

HONG KONG OBSERVATORY

Technical Note No. 95

**CLIMATOLOGY OF LAU FAU SHAN
1986-1997**

by

M.C. NG & W.M. CHAN

COPYRIGHT RESERVED

Published April 1999

Prepared by

Hong Kong Observatory
134A Nathan Road
Kowloon
Hong Kong

This publication is prepared and disseminated in the interest of promoting information exchange. The findings, conclusions and views contained herein are those of the authors and not necessarily those of the Hong Kong Observatory or the Government of the Hong Kong Special Administrative Region.

The Government of the Hong Kong Special Administrative Region (including its servants and agents) makes no warranty, statement or representation, express or implied, with respect to the accuracy, completeness, or usefulness of the information contained herein, and in so far as permitted by law, shall not have any legal liability or responsibility (including liability for negligence) for any loss, damage, or injury (including death) which may result, whether directly or indirectly, from the supply or use of such information.

Mention of product of manufacturer does not necessarily constitute or imply endorsement or recommendation.

Permission to reproduce any part of this publication should be obtained through the Hong Kong Observatory.

551.506.1:551.582(512.317)

摘要

本報告是流浮山自動氣象站在 1986 - 1997 期間的氣候摘要。除列出標準氣候圖表外，亦將流浮山的紀錄與橫瀾島的風紀錄及天文台的氣溫紀錄作出比較。

Abstract

This note gives a climatological summary for Lau Fau Shan Automatic Weather Station during 1986-1997. In addition to standard climatological tables and diagrams, comparisons of wind with Waglan Island and temperature with Hong Kong Observatory are also made.

CONTENTS

FIGURES

TABLES

1. INTRODUCTION
2. HISTORY OF THE STATION
3. DATA
4. INSTRUMENTS AND METHODS OF OBSERVATION
 - (a) Atmospheric pressure
 - (b) Air temperature, dew point and relative humidity
 - (c) Wind
 - (d) Rainfall
5. ANALYSIS
 - (a) Climatological summary
 - (b) Monthly and annual wind roses
 - (c) Diurnal variation of wind
 - (d) Hourly means of meteorological elements
 - (e) Gust factor
 - (f) Extreme values of temperature, rainfall and gust
 - (g) Comparison of wind with Waglan Island
 - (h) Comparison of temperature with Hong Kong Observatory

ACKNOWLEDGEMENT

REFERENCES

FIGURES

1. Location of Lau Fau Shan Automatic Weather Station
2. Locations of weather stations
3. (a) The instruments at Lau Fau Shan looking towards the northeast.
(b) The anemometer at Lau Fau Shan looking towards the northwest overlooking Deep Bay
4. Annual wind rose for Lau Fau Shan, 1986-1997
5. Monthly wind roses from January to June for Lau Fau Shan, 1986-1997
6. Monthly wind roses from July to December for Lau Fau Shan, 1986-1997
7. Hourly vector mean wind from January to June at Lau Fau Shan, 1986-1997
8. Hourly vector mean wind from July to December at Lau Fau Shan, 1986-1997
9. Diurnal variation of mean sea-level pressure at Lau Fau Shan, 1986-1997
10. Diurnal variation of air temperature at Lau Fau Shan, 1986-1997
11. Diurnal variation of dew point at Lau Fau Shan, 1986-1997
12. Diurnal variation of relative humidity at Lau Fau Shan, 1986-1997
13. Frequency distribution of the difference in hourly mean wind directions between Lau Fau Shan (LFS) and Waglan Island (WGL), grouped according to the wind direction at Waglan Island
14. Comparison of daily maximum, minimum and mean temperatures between Lau Fau Shan and the Observatory

TABLES

1. CLIMATOLOGICAL SUMMARY FOR LAU FAU SHAN, 1986-1997
2. PERCENTAGE FREQUENCY OF OCCURRENCE OF HOURLY WIND DIRECTON AND SPEED WITHIN SPECIFIED RANGES AT LAU FAU SHAN, 1986-1997
3. HOURLY VECTOR MEAN WIND AT LAU FAU SHAN, 1986-1997
4. HOURLY MEAN OF MEAN SEA-LEVEL PRESSURE AT LAU FAU SHAN, 1986-1997
5. HOURLY MEAN OF AIR TEMPERATURE AT LAU FAU SHAN, 1986-1997
6. HOURLY MEAN OF DEW POINT AT LAU FAU SHAN, 1986-1997
7. HOURLY MEAN OF RELATIVE HUMIDITY AT LAU FAU SHAN, 1986-1997
8. EXTREME VALUES OF TEMPERATURE, RAINFALL AND GUST AT LAU FAU SHAN, 1986-1997

1. INTRODUCTION

Automatic weather stations were set up in Hong Kong to meet increasing demands for regional meteorological data for engineering projects in areas under development and to improve weather services. There are 26 such stations in operation at present. Lau Fau Shan Automatic Weather Station is one of these stations with a history of more than 13 years. This note is to give a climatological summary for this station.

2. HISTORY OF THE STATION

Lau Fau Shan Automatic Weather Station (22°28'14" N, 113°58'52" E) has been in operation since 16 September 1985. It is situated at Lau Fau Shan Police Station and is adjacent to Hau Hoi Wan about 5 km northwest of Yuen Long town centre. Its location is shown in Figure 1 and 2.

The high hills around the station are :

Kai Kung Leng	(572 m)	10 km to E
Castle Peak	(583 m)	9 km to SSW
Hill east of Tuen Mun	(507 m)	7 km to S

3. DATA

The data used in this note are hourly records measured at Lau Fau Shan Automatic Weather Station between January 1986 and December 1997. A total of 105 192 observations was loaded into the Oracle database of the Hong Kong Observatory and analyzed using SQL (Structured Query Language). It should be noted that there are periods of incomplete data due to equipment or transmission failure.

4. INSTRUMENTS AND METHODS OF OBSERVATION

At automatic weather stations, measurements of wind, dry-bulb temperature, dew point, relative humidity, atmospheric pressure and rainfall are recorded by automatic instruments and data are transmitted to the Hong Kong Observatory at one-minute intervals via telephone circuits. Figures 3(a) and (b) show the instruments viewed from different directions. The following paragraphs describe the instruments and methods of observation used in Lau Fau Shan during the years 1986-1997.

(a) Atmospheric pressure

Atmospheric pressure was measured with a Setra Systems digital barometer, model 361B.

Height above floor = 1.5 m

Height above mean sea-level = 35.5 m

(b) Air temperature, dew point and relative humidity

Dry-bulb temperature and dew point were measured with a Climatronics temperature and dew-point sensor with its sensing elements placed in a Stevenson screen box. Values of relative humidity were calculated from the dry-bulb temperature and dew point. The measurement of dew point has ceased since June 1995.

Daily maximum and minimum temperatures were extracted from 1-minute data in each day.

(c) Wind

Winds were measured with a Mark V cup and vane anemometer with its head 49.7 m above mean sea-level. Hourly mean wind was computed from the 1-minute data in the hour (Yeung et al 1987).

(d) Rainfall

Rainfall was recorded with a Casella tipping bucket rain-gauge with a step size of 0.5 mm.

5. ANALYSIS

(a) Climatological summary

Monthly values of meteorological elements are summarized in Table 1. Readers are reminded that data are subject to loss because of equipment or transmission failure. The effect on rainfall is significant due to missing records during some major rainstorms particularly in July 1994 and October 1995. In such cases, monthly rainfall totals were adjusted using monthly rainfall distribution maps.

(b) Monthly and annual wind roses

The total number of occurrences of concurrent wind speed and direction is computed for each month. Wind directions are grouped into ranges of 30° and wind speeds in m/s into categories as follows: 0.1-3.2, 3.3-8.2, 8.3-14.2 and >14.2 . The percentage frequencies are shown in Table 2 and are plotted in the form of wind roses in Figures 4-6.

It can be seen that the most frequent and prevailing wind direction is east-northeast for September-April and southeast for May-August (see Table 1).

(c) Diurnal variation of wind

Hourly vector mean winds are computed for each month. These are shown in Table 3 and plotted in Figures 7-8. The study of the sea-land breeze system in Hong Kong (Zhang and Zhang 1997) indicates that the land breeze near Lau Fau Shan is generally northeasterly while the sea breeze is westerly in winter and southwesterly in summer. Dominated by this effect, winds back in the afternoon and maximum wind speeds occur in the morning from September to February while winds veer in the afternoon and maximum wind speeds occur in the evening from March to August. It should be noted that in August and September, winds fluctuate considerably in direction under light wind conditions.

(d) Hourly means of meteorological elements

Hourly means in each month for the following elements are shown in Tables 4-7 and are plotted in Figures 9-12.

- (i) mean sea-level pressure
- (ii) air temperature
- (iii) dew point
- (iv) relative humidity

(e) Gust factor

Gust factor is defined as the ratio of hourly instantaneous maximum gust to hourly mean wind. Using the regression equation of gust(G) on hourly mean wind(M), gust factor(GF) can be obtained.

If the regression equation is written as

$$G = a M + b$$

then

$$GF = a + b/M$$

Regression equations for winds in different quadrants and their corresponding gust factors are shown below :

$$G = 1.46 M + 1.69 , \quad r=0.90 \quad (\text{direction between } 050^\circ \text{ and } 130^\circ , \text{ east })$$

$$G = 1.44 M + 1.96 , \quad r=0.92 \quad (\text{direction between } 140^\circ \text{ and } 220^\circ , \text{ south })$$

$$G = 1.06 M + 2.49 , \quad r=0.86 \quad (\text{direction between } 230^\circ \text{ and } 310^\circ , \text{ west })$$

$$G = 1.28 M + 2.24 , \quad r=0.90 \quad (\text{direction between } 320^\circ \text{ and } 040^\circ , \text{ north })$$

where r is the correlation coefficient.

Hourly Mean Wind (m/s)	Gust factor			
	East	South	West	North
5	1.80	1.83	1.56	1.73
10	1.63	1.64	1.31	1.50
15	1.57	1.57	1.23	1.43
20	1.54	1.54	1.18	1.39
25	1.53	1.52	1.16	1.37

(f) Extreme values of temperature, rainfall and gust

The top 20 extreme values of maximum and minimum temperatures, maximum gust and maximum hourly, daily and monthly rainfall are listed in Table 8. The extreme values recorded at the Hong Kong Observatory during the same period are also given on the last line for comparison.

Extreme maximum temperatures were due to subsidence ahead of tropical cyclones or prolonged fine weather brought about by ridges. Extreme minimum temperatures were due to cold surges in winter times.

The heaviest rainfall at Lau Fau Shan, as characteristic of Hong Kong, was brought by tropical cyclones and monsoon troughs.

The occurrences of maximum gusts were mostly recorded during the passage of tropical cyclones. They were Faye (July 1992), Koryn (June 1993), Becky (September 1993), Caitlin (August 1994), Helen and Kent (August 1995) and Victor (August 1997). The exceptions are the

case on 6 July 1992 (Rank 9) when a strong southwest monsoon affected the coastal areas and the case on 17 May 1994 (Rank 13) when a northeast monsoon affected the territory.

(g) Comparison of wind with Waglan Island

Differences in wind direction between Lau Fau Shan and Waglan Island, grouped by four quadrants (as in (e) above), are measured with the angle veering or backing from the prevailing wind direction recorded at Waglan Island. These differences are shown in Figure 13. The distributions are single-peak and bell-shaped. Winds at Lau Fau Shan most often veer 30 degrees from the northerlies at Waglan but back 10, 30 and 40 degrees from the easterlies, southerlies and westerlies at Waglan respectively.

Regression equations of hourly wind speeds at Lau Fau Shan (LFS) against those at Waglan Island (WGL) in different quadrants with the speed at Waglan Island exceeding 5 m/s are shown below:

East	:	$VLFS = 0.24 VWGL + 1.41$	$(r = 0.43)$
South	:	$VLFS = 0.42 VWGL + 1.21$	$(r = 0.48)$
West	:	$VLFS = 0.60 VWGL + 0.15$	$(r = 0.54)$
North	:	$VLFS = 0.35 VWGL + 1.32$	$(r = 0.55)$

The linear relationships can only be regarded as fair, as reflected by the small values of correlation coefficients. The wind speed of Lau Fau Shan is about 35% of that at Waglan Island with easterlies, 45% with northerlies and 60 % from other wind directions.

(h) Comparison of temperature with Hong Kong Observatory

Regression equations of daily maximum, minimum and mean temperatures at Lau Fau Shan against those at the Observatory (HKO) are shown below:

daily maximum temperature	:	$TLFS = 1.02 THKO + 0.18$	$(r = 0.96)$
daily minimum temperature	:	$TLFS = 1.08 THKO - 3.04$	$(r = 0.98)$
daily mean temperature	:	$TLFS = 1.06 THKO - 1.90$	$(r = 0.99)$

Excellent linear relationships can be seen in the scatter diagrams with associated regression lines shown in Figure 14.

Generally, the daily maximum temperature is about 1 °C higher than that of the Observatory in summer while the daily minimum temperature is about 2 °C lower in winter. Daily mean temperature is almost the same in summer and 1 °C lower in winter at Lau Fau Shan.

ACKNOWLEDGEMENT

The authors would like to thank Mr. W.K. Kwan for his valuable comments on reviewing this note.

REFERENCES

1. Chen, T.Y. 1975 Comparison of Surface Winds in Hong Kong, Hong Kong Observatory Technical Note No. 41
2. Lui, W.H. 1991 Preliminary Analysis of Wind Data Recorded by Automatic Weather Stations in Hong Kong, Hong Kong Observatory Technical Note (Local) No. 59
3. Ng, M.C. and K.P. Wong 1996 30-Year Mean Rainfall in Hong Kong 1961-1990, Hong Kong Technical Note No. 88
4. Yeung, K.H., K.K. Ng and L.K. Yau 1987 A Solar-powered Automatic Weather Station, Hong Kong Observatory Technical Note No. 75
5. Zhang M. and L.F. Zhang 1997 Hong Kong Meteorological Society Bulletin Vol. 7, No. 1 1997, 22-43

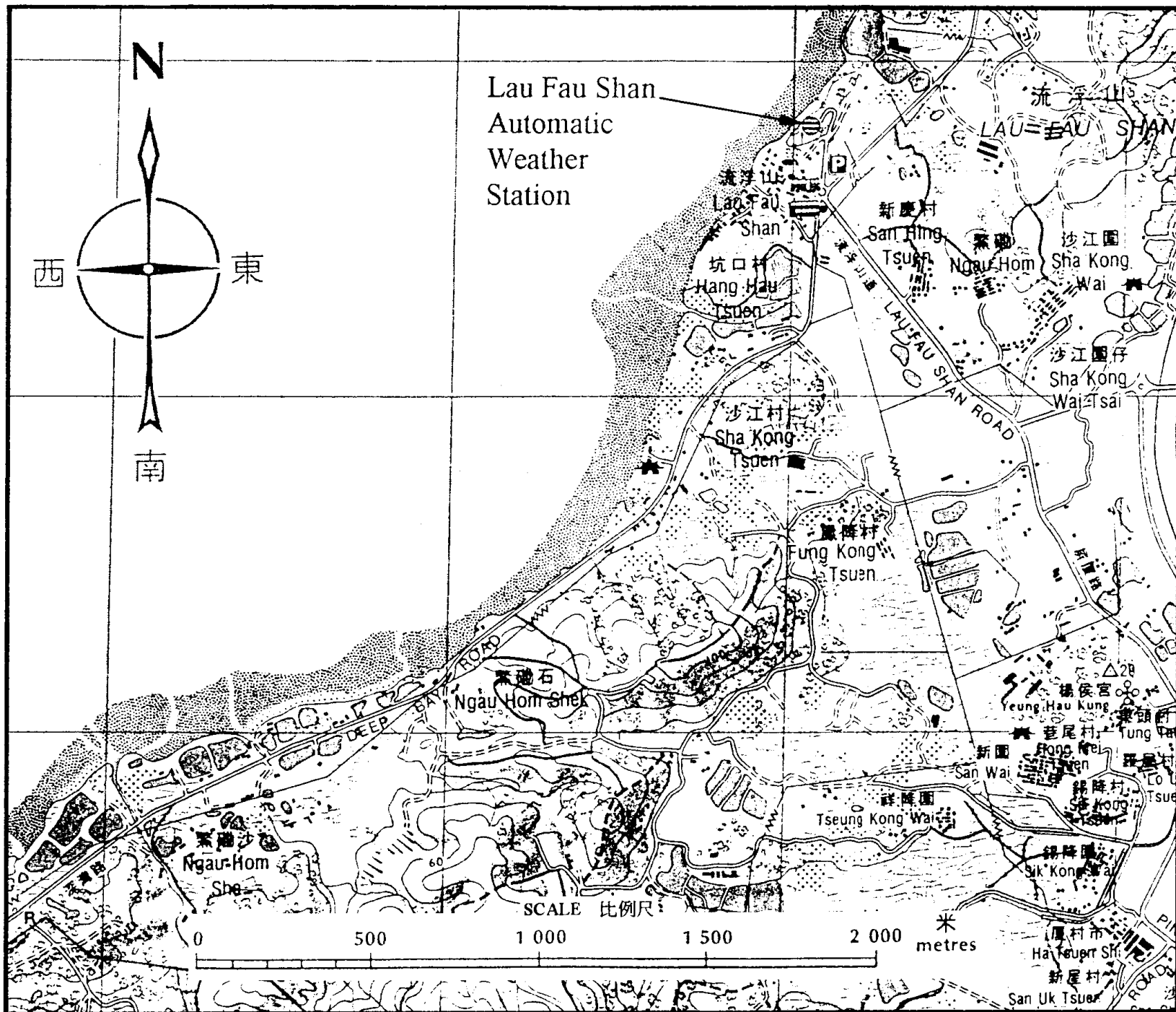

Fig. 1. Location of Lau Fau Shan Automatic Weather Station.

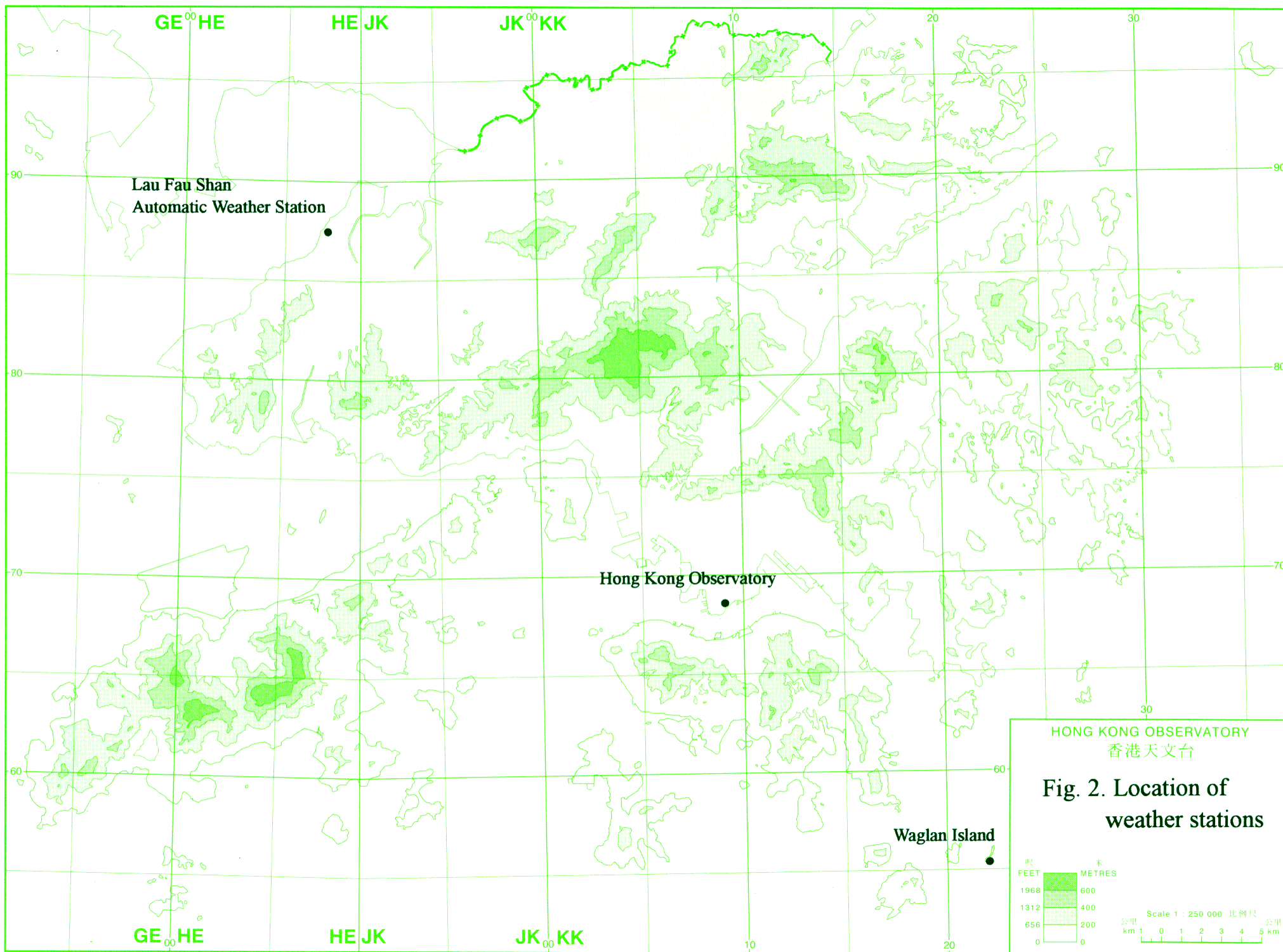



Fig. 3(a). The instruments at Lau Fau Shan looking towards the northeast. The anemometer mast is on the roof to the left and the rain-gauge is on the roof of the hut in front of the mast.

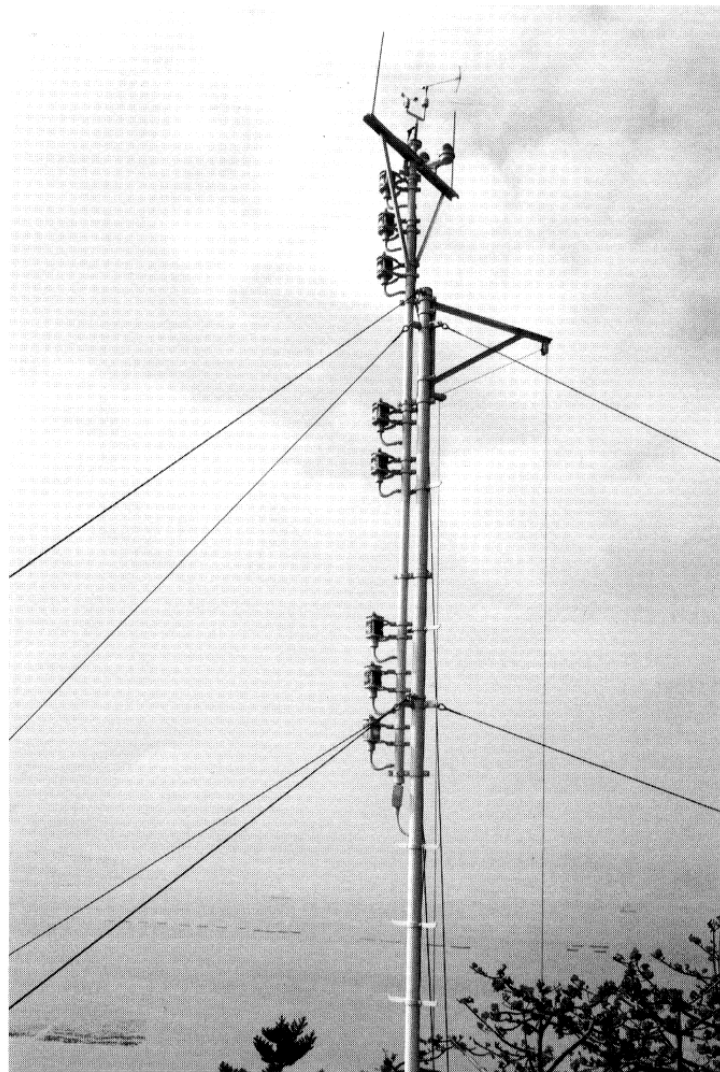

Fig. 3(b). The anemometer at Lau Fau Shan looking towards the northwest overlooking Deep Bay.

LAU FAU SHAN AUTOMATIC WEATHER STATION

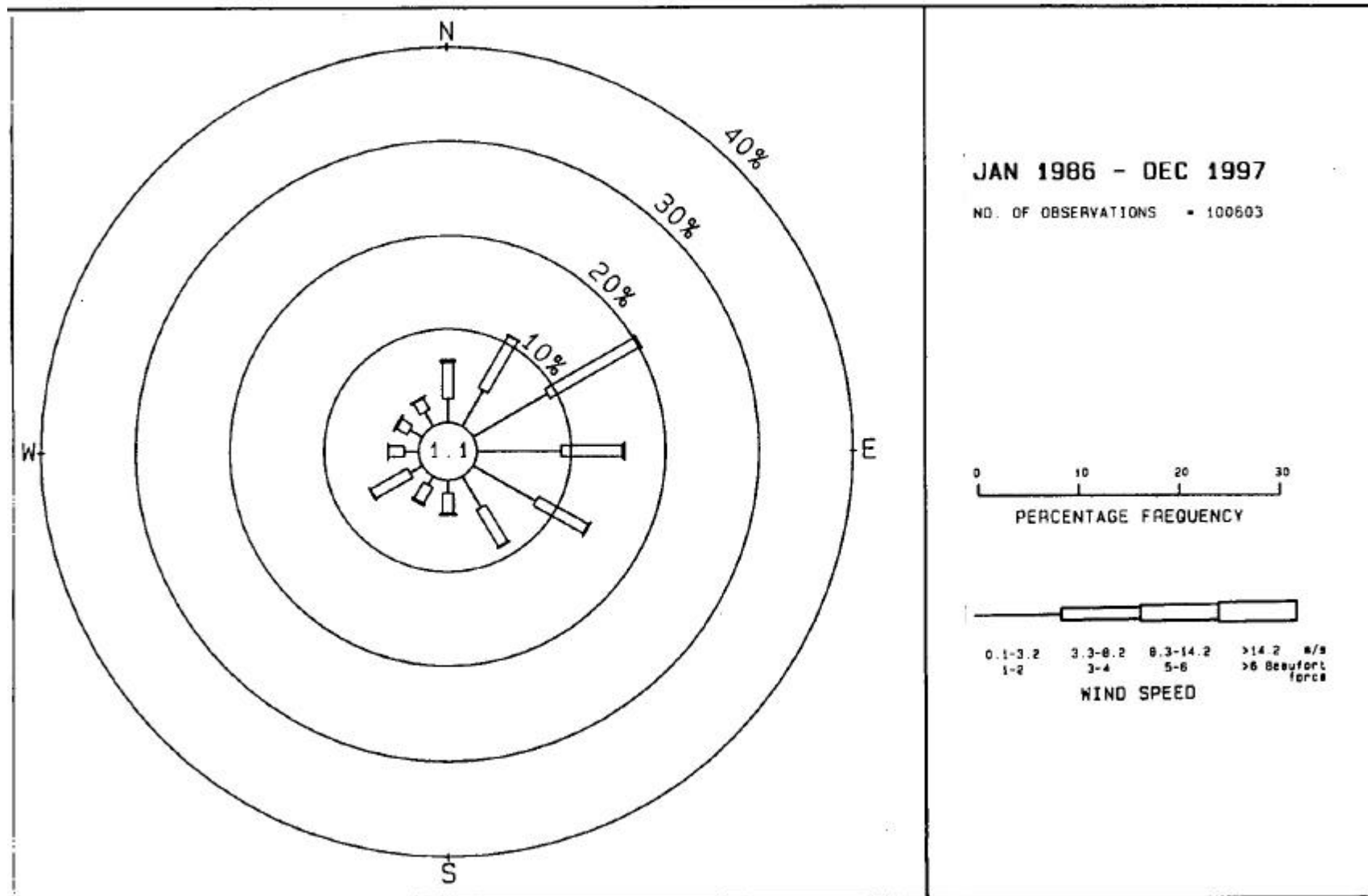
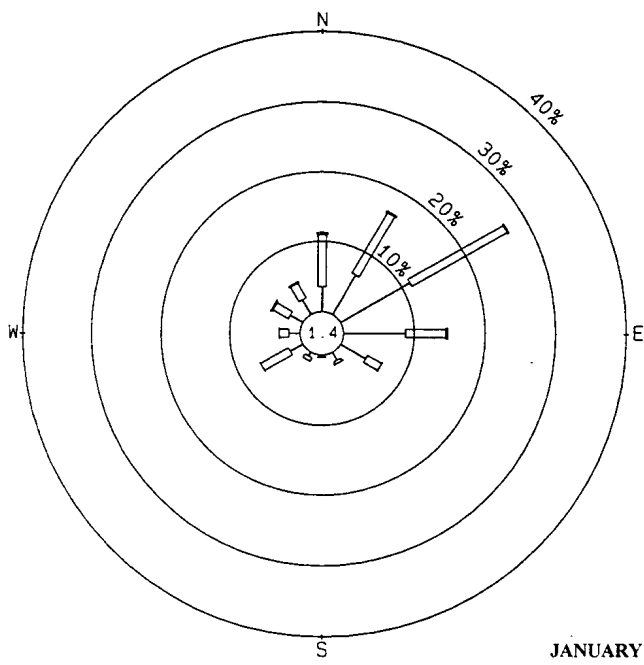
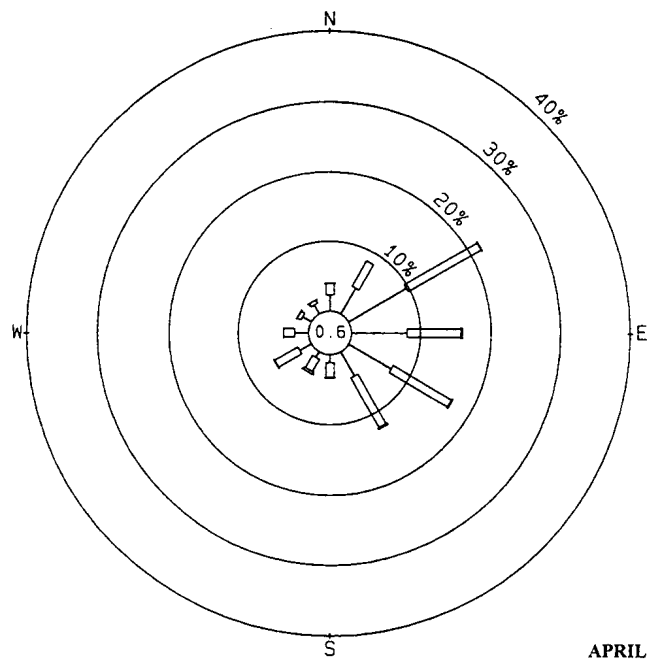

Fig. 4. Annual wind rose for Lau Fau Shan, 1986-1997.



JANUARY



APRIL

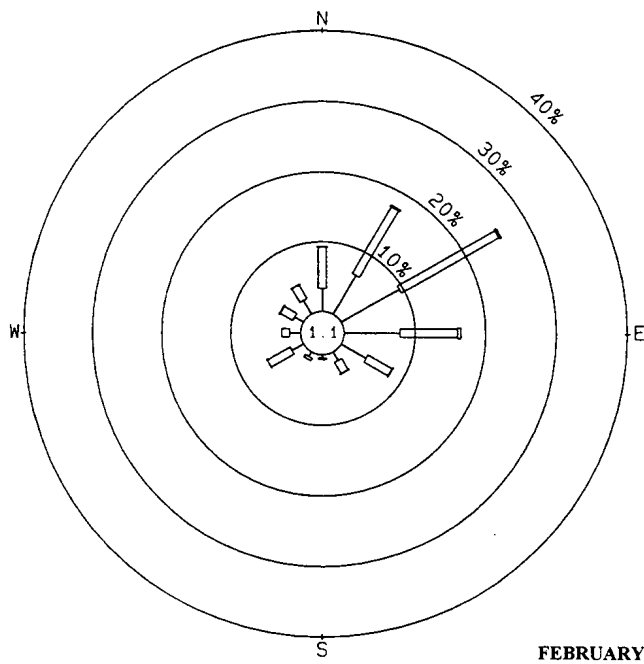

FEBRUARY

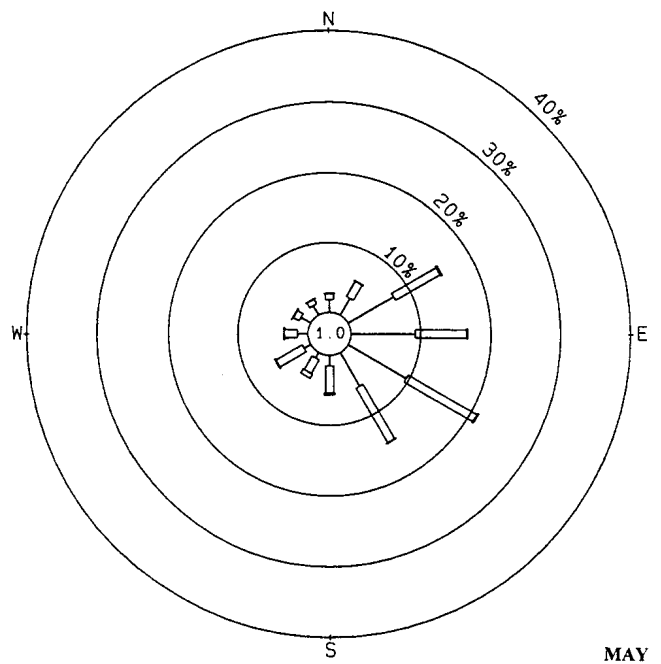

MAY

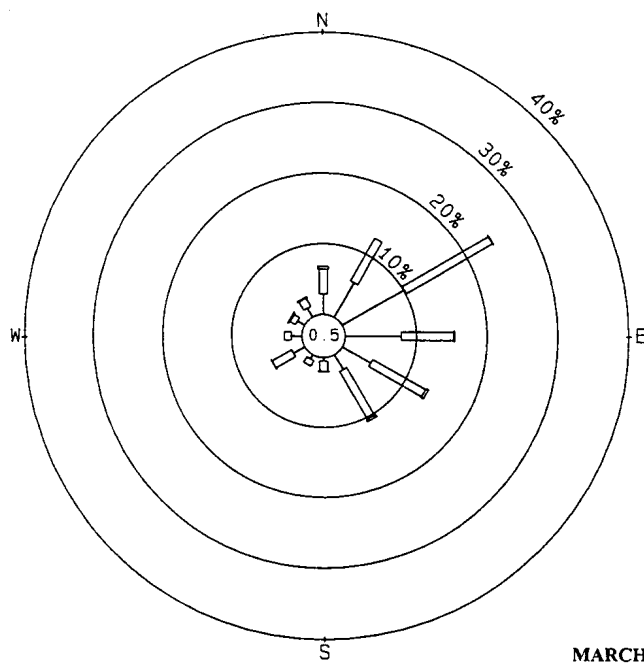

MARCH

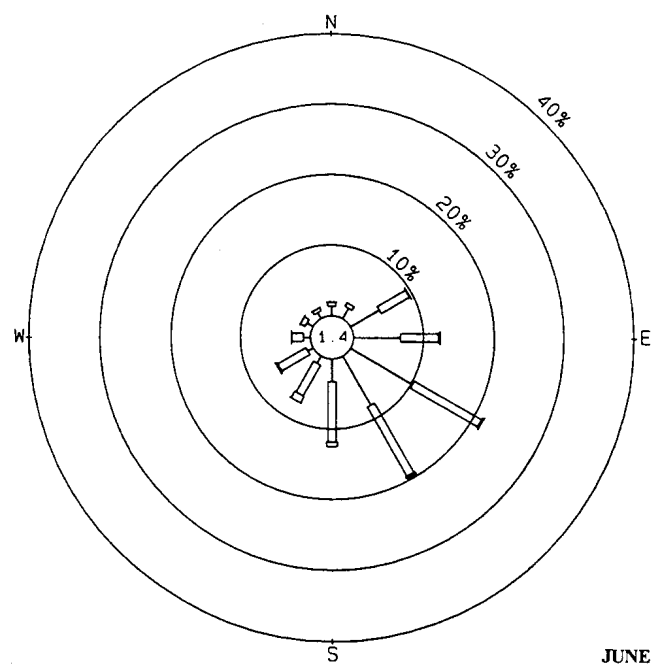

JUNE

Fig. 5. Monthly wind roses from January to June for Lau Fau Shan, 1986-1997.

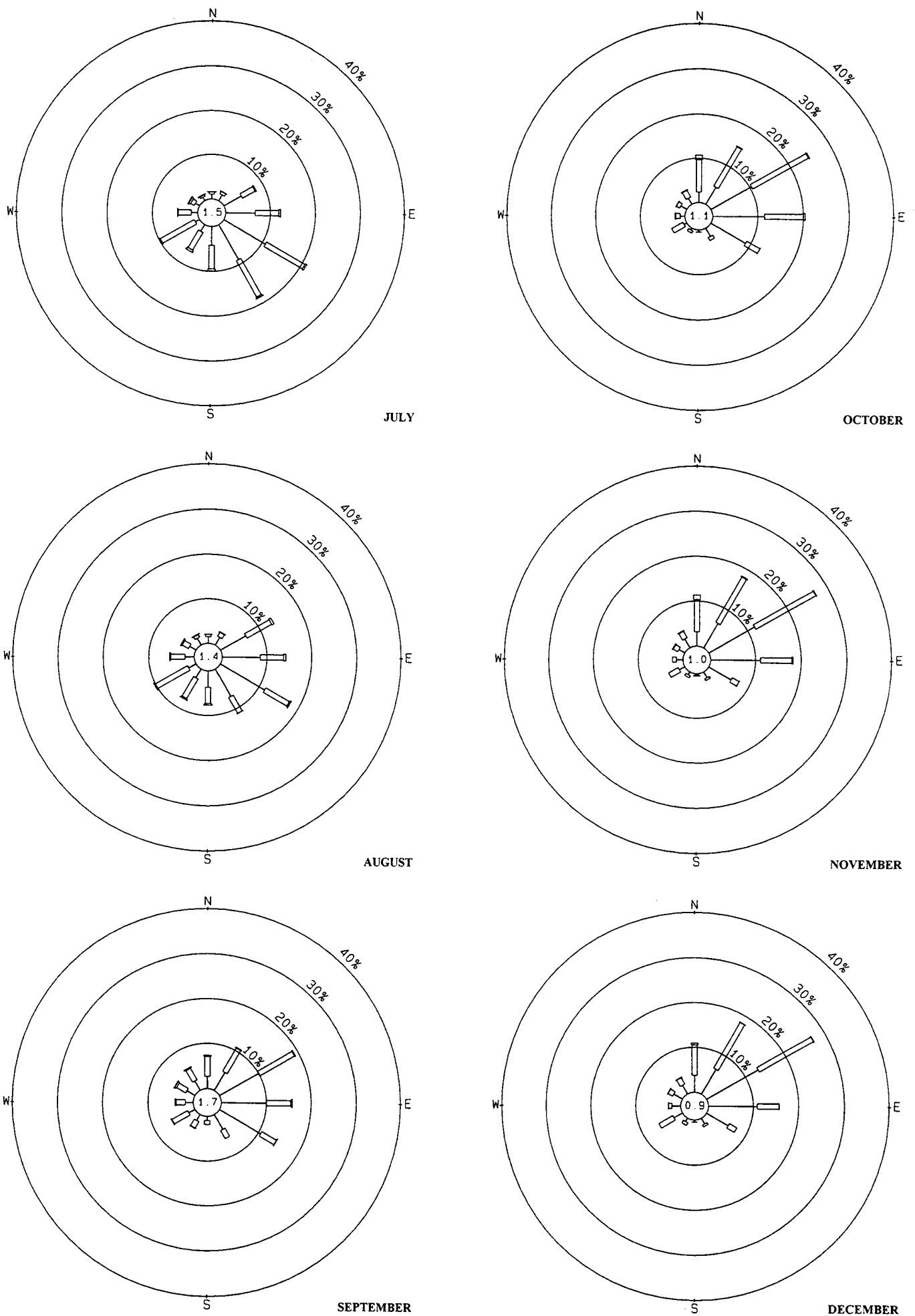

Fig. 6. Monthly wind roses from July to December for Lau Fau Shan, 1986-1997.

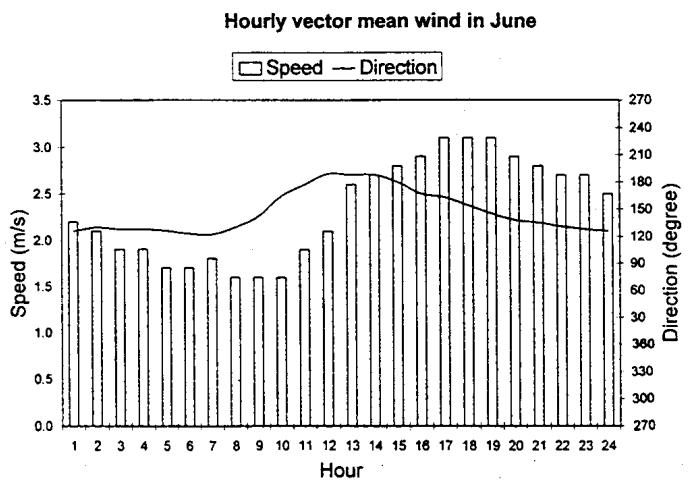
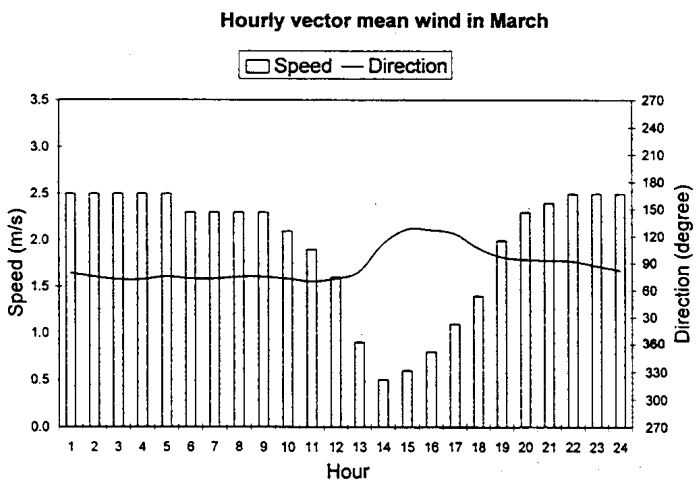
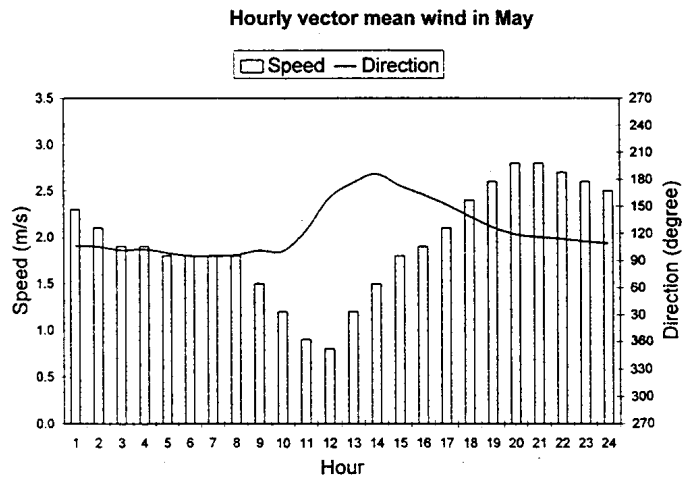
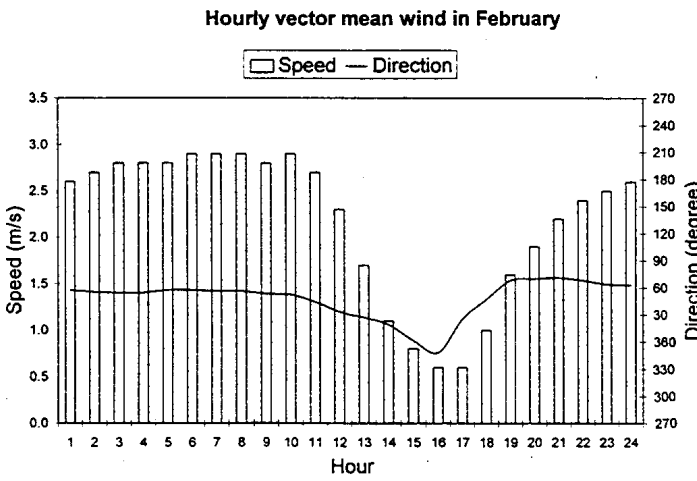
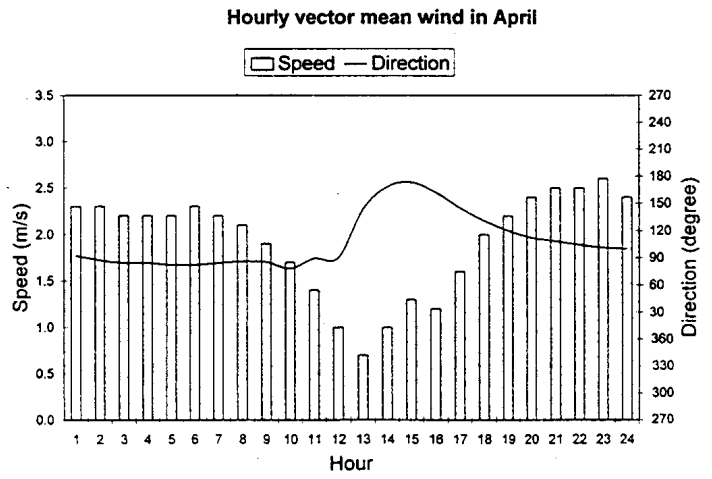
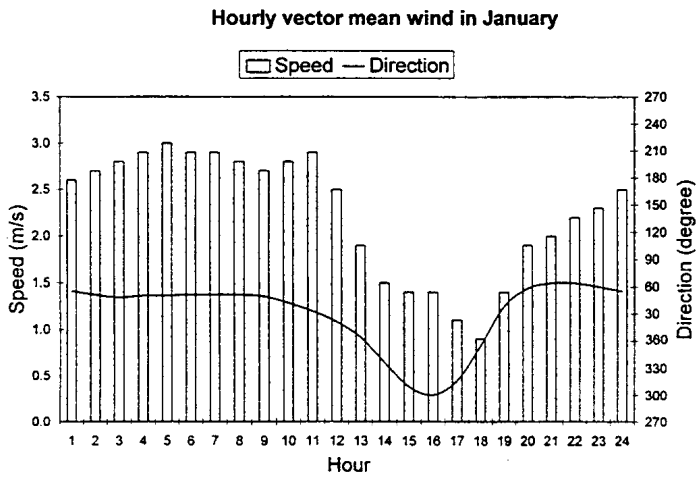

Fig. 7. Hourly vector mean wind from January to June at Lau Fau Shan, 1986-1997.

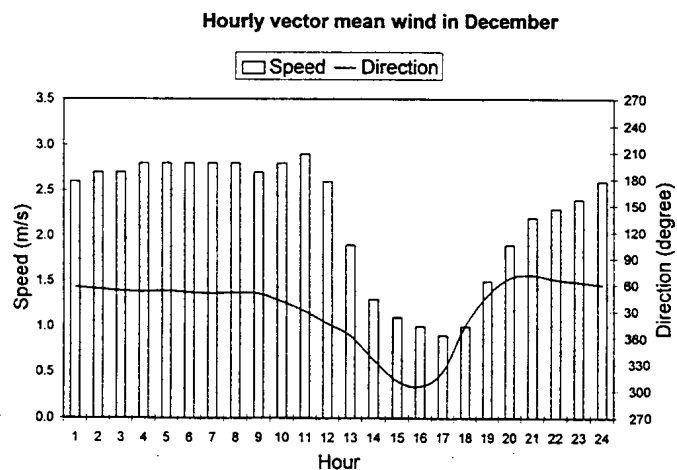
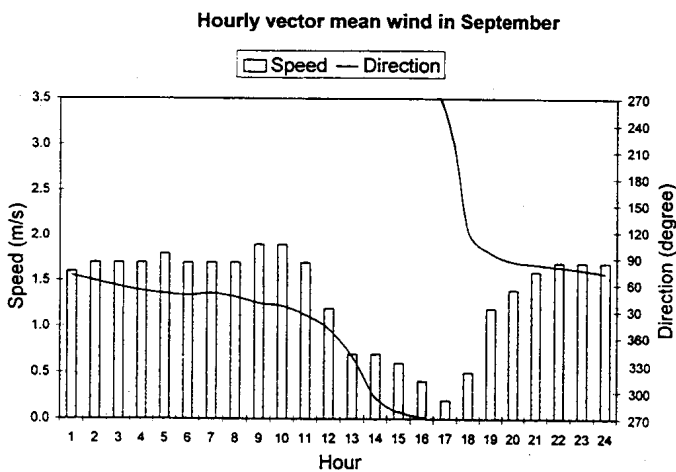
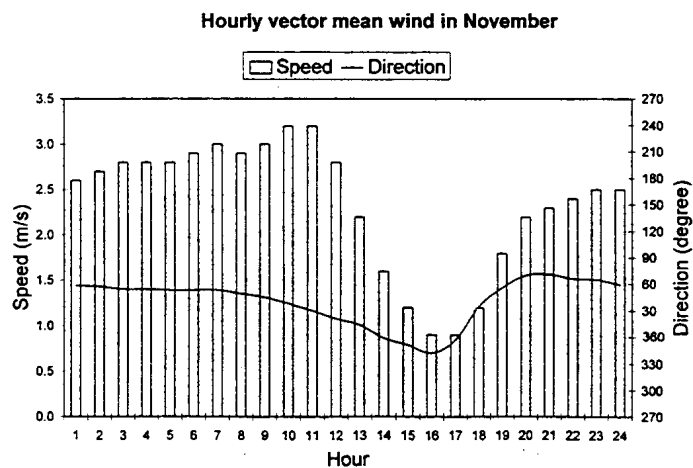
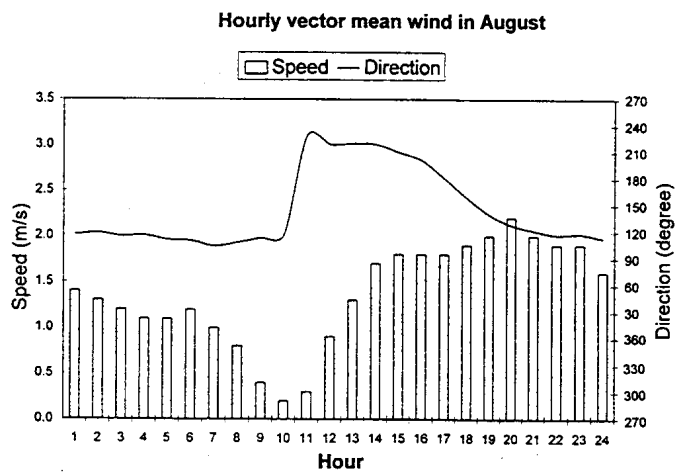
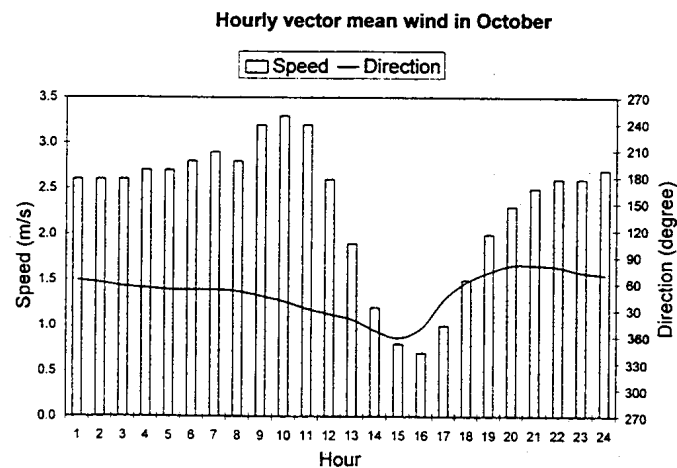
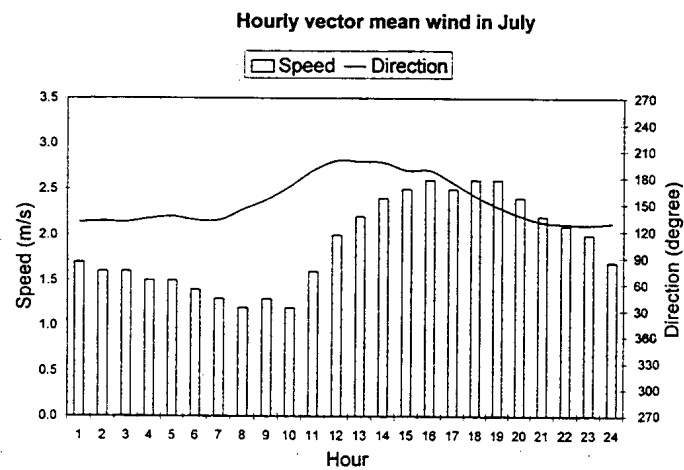

Fig. 8. Hourly vector mean wind from July to December at Lau Fau Shan, 1986-1997.

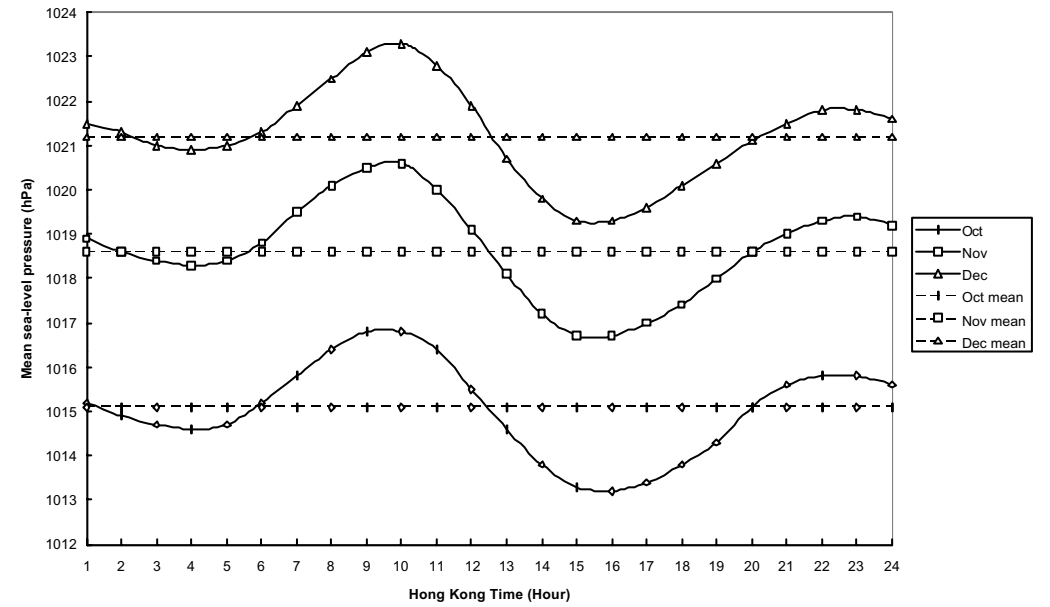
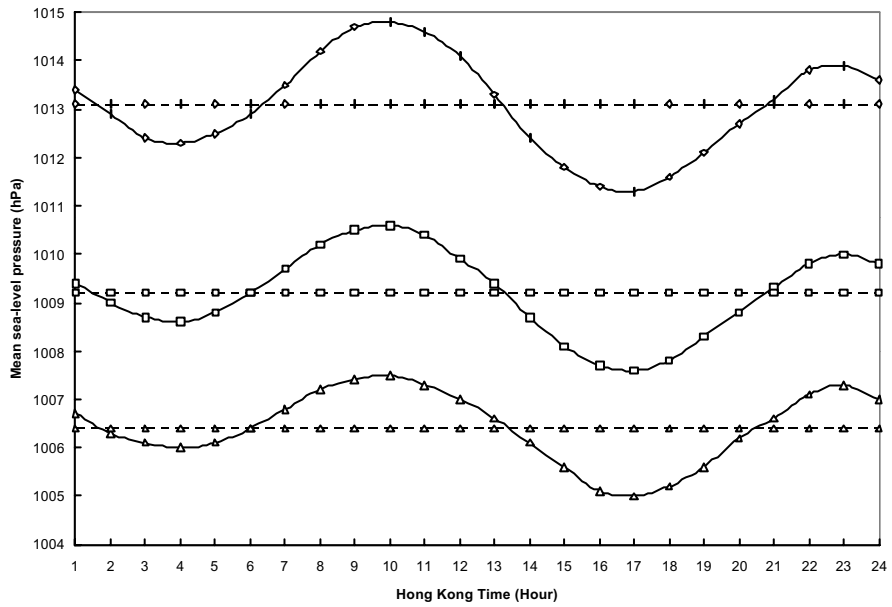
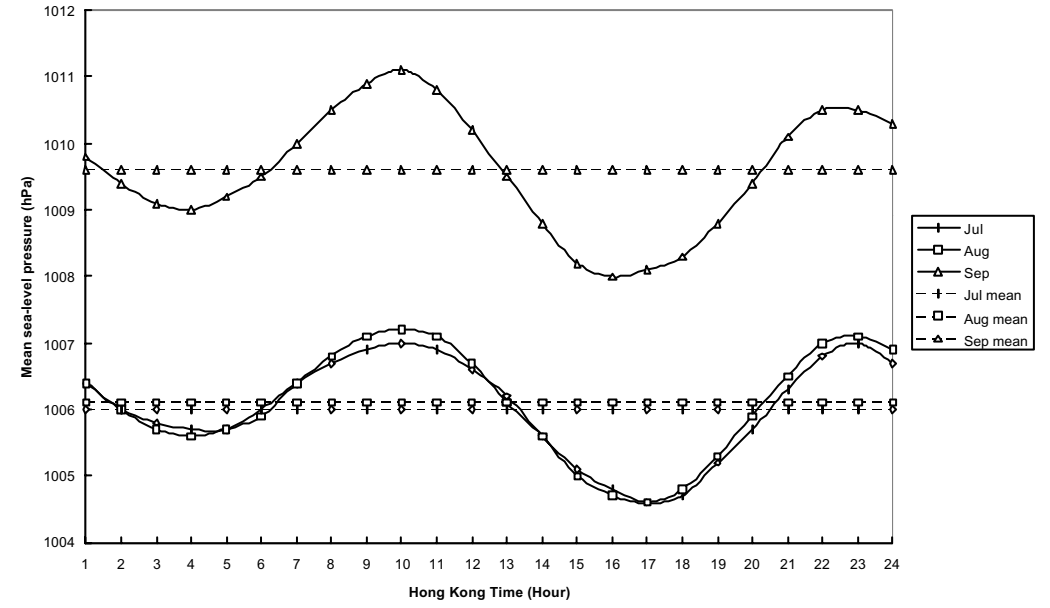
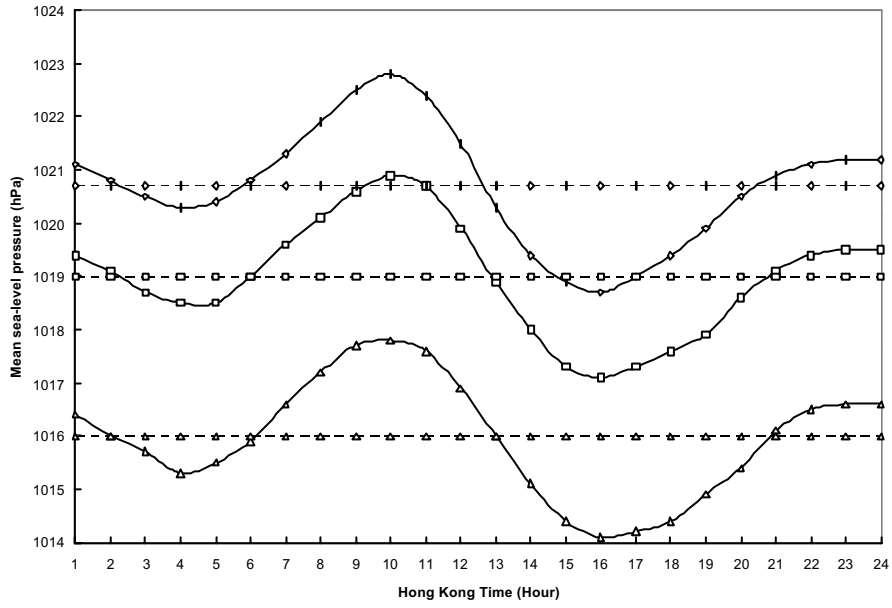

Fig. 9. Diurnal variation of mean sea-level pressure at Lau Fau Shan, 1986-1997.

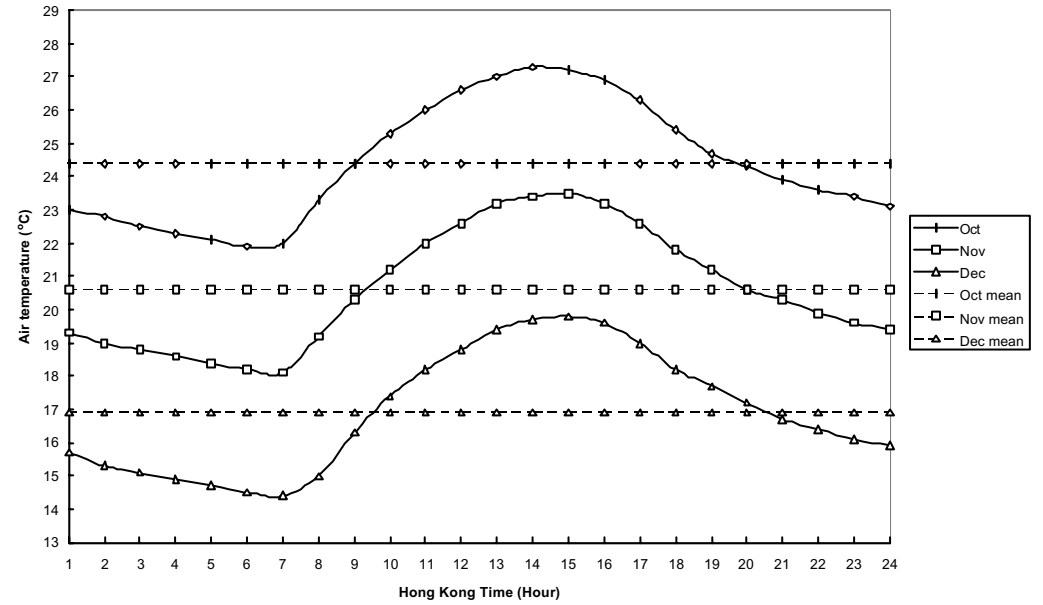
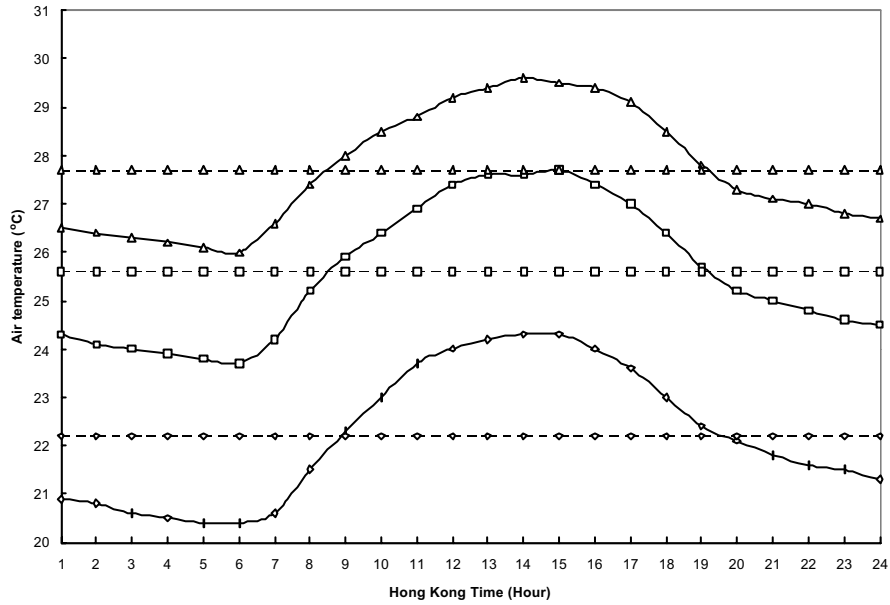
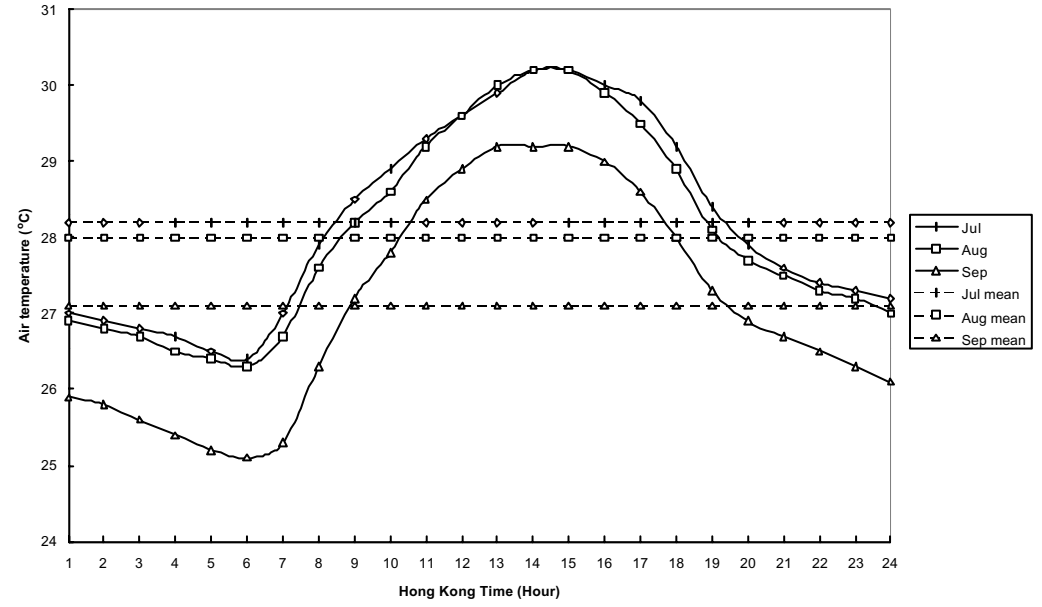
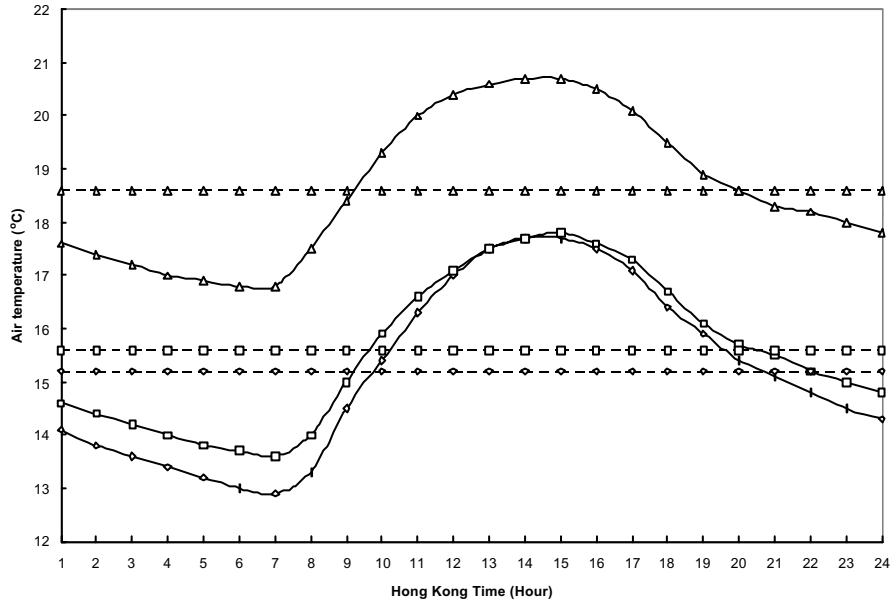

Fig. 10. Diurnal variation of air temperature at Lau Fau Shan, 1986-1997.

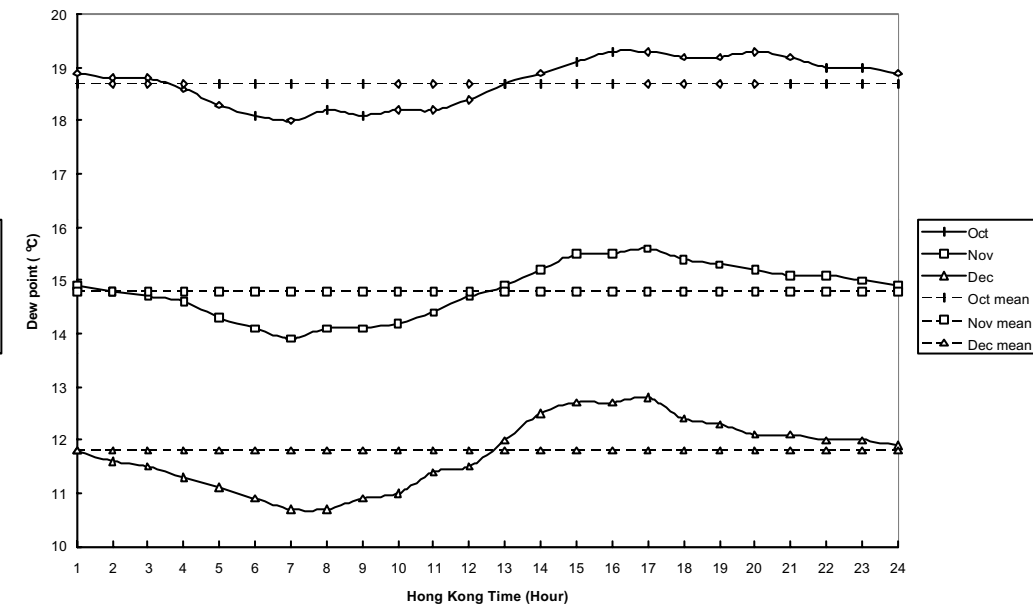
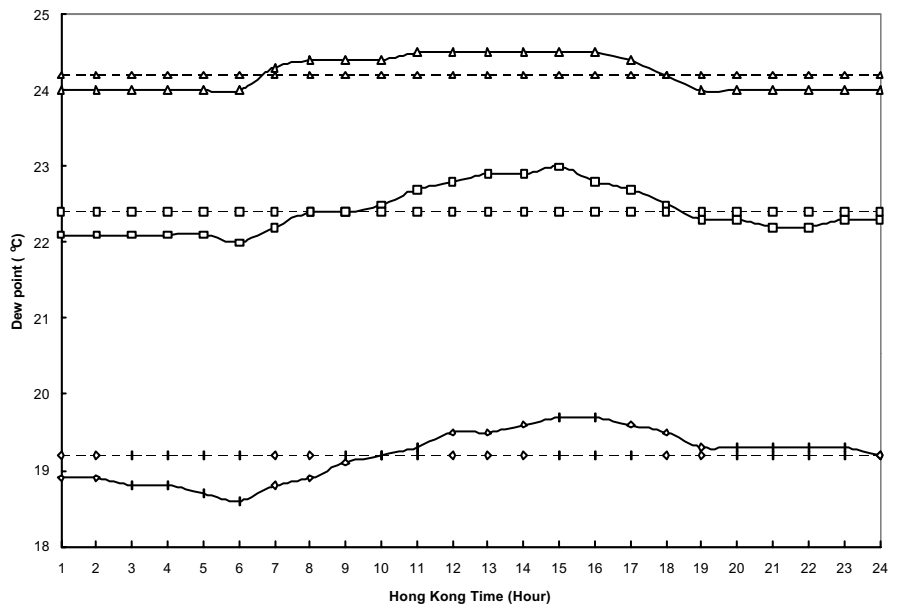
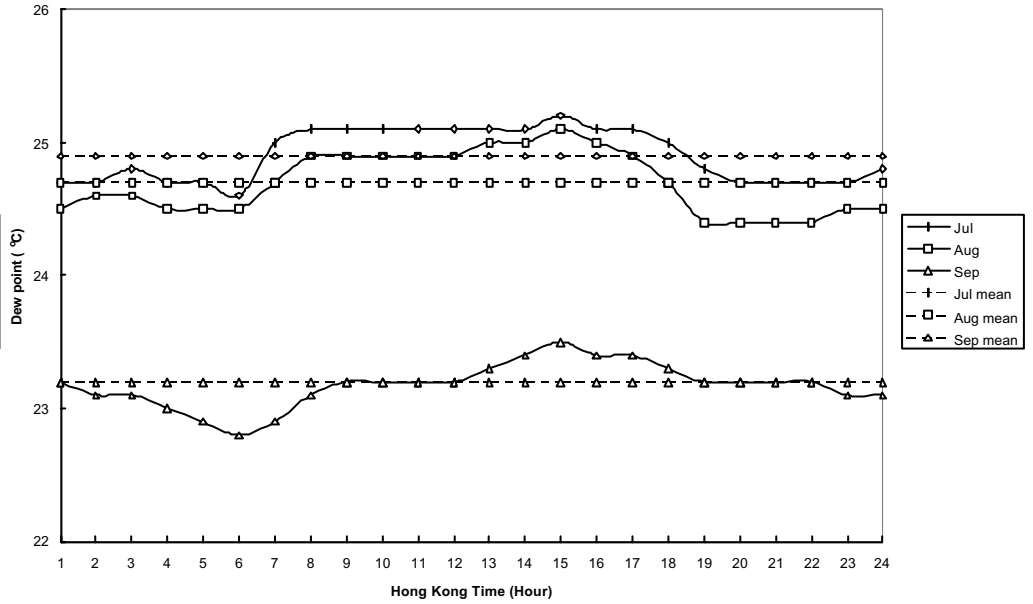
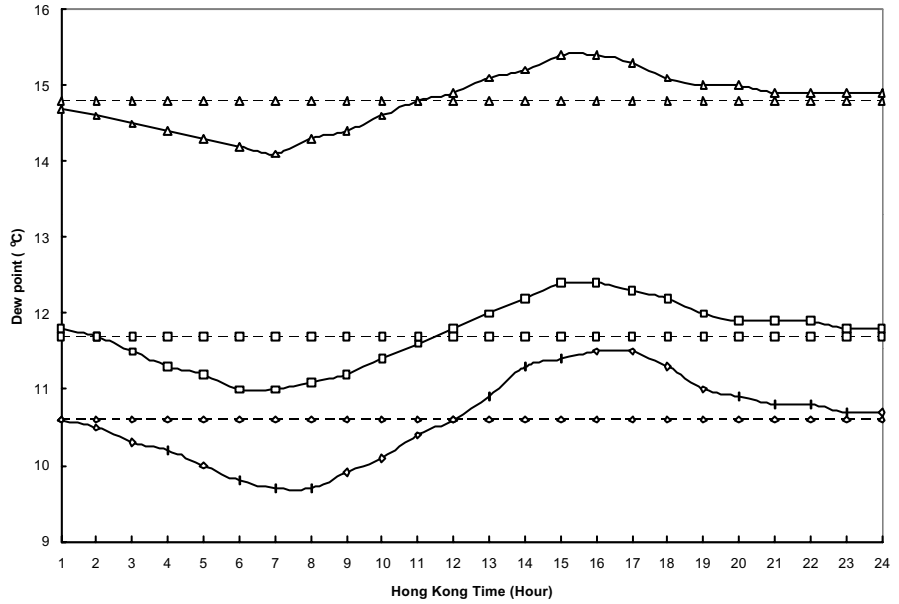

Fig. 11. Diurnal variation of dew point at Lau Fau Shan, 1986-1997.

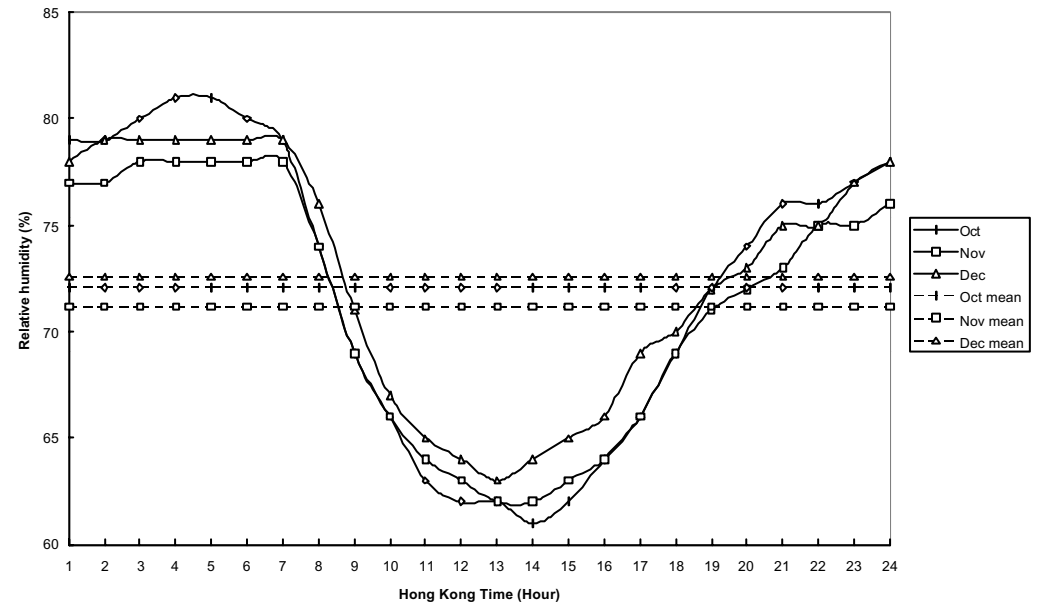
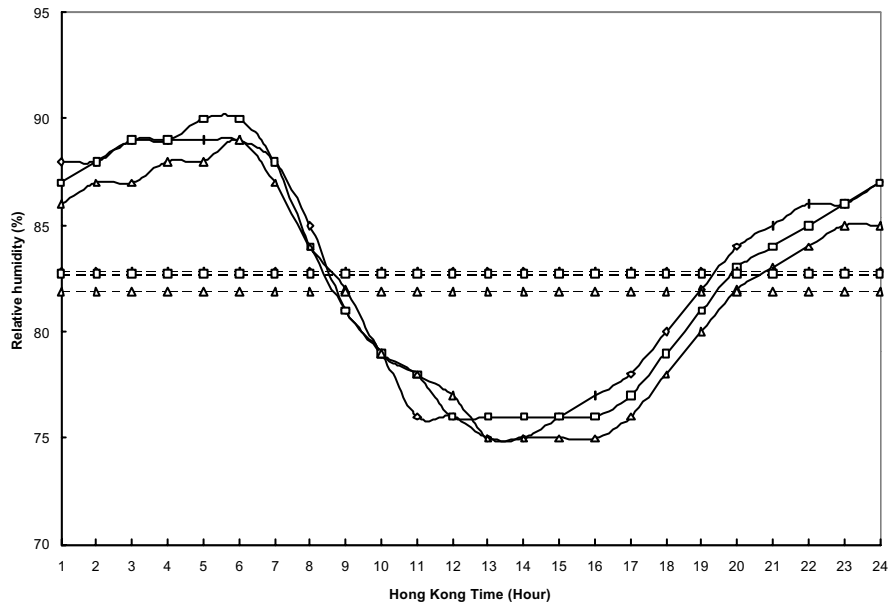
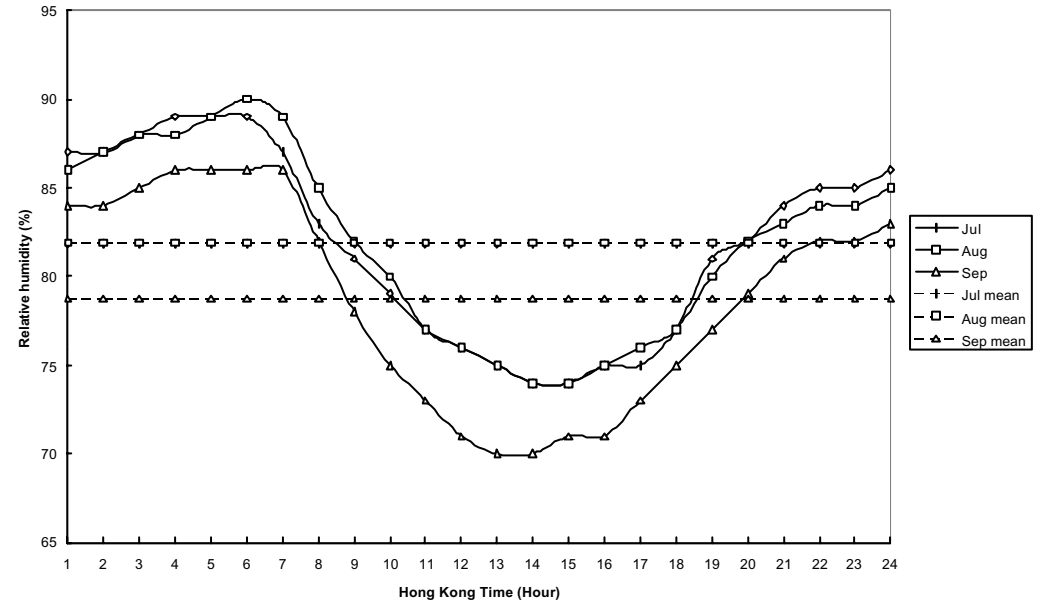
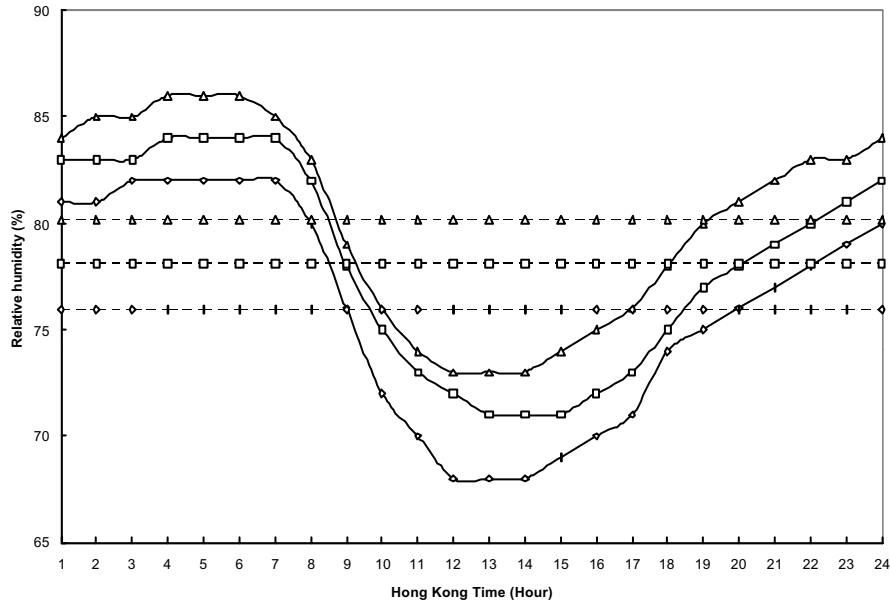

Fig. 12. Diurnal variation of relative humidity at Lau Fau Shan, 1986-1997.

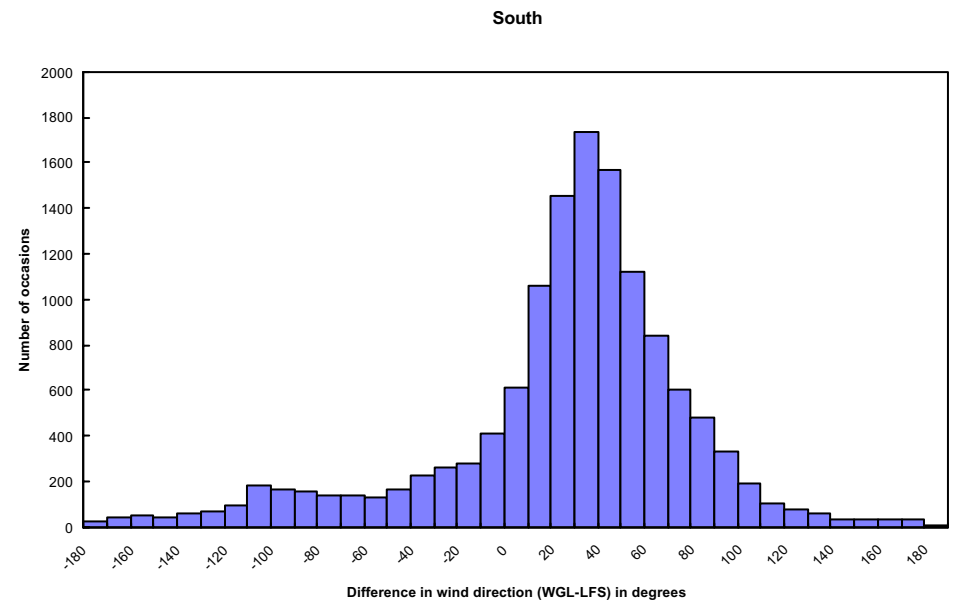
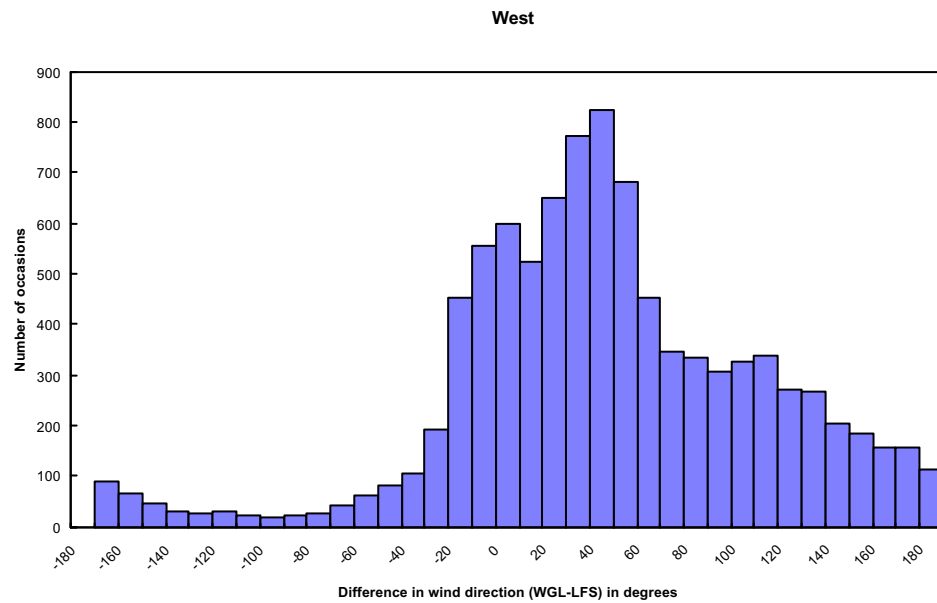
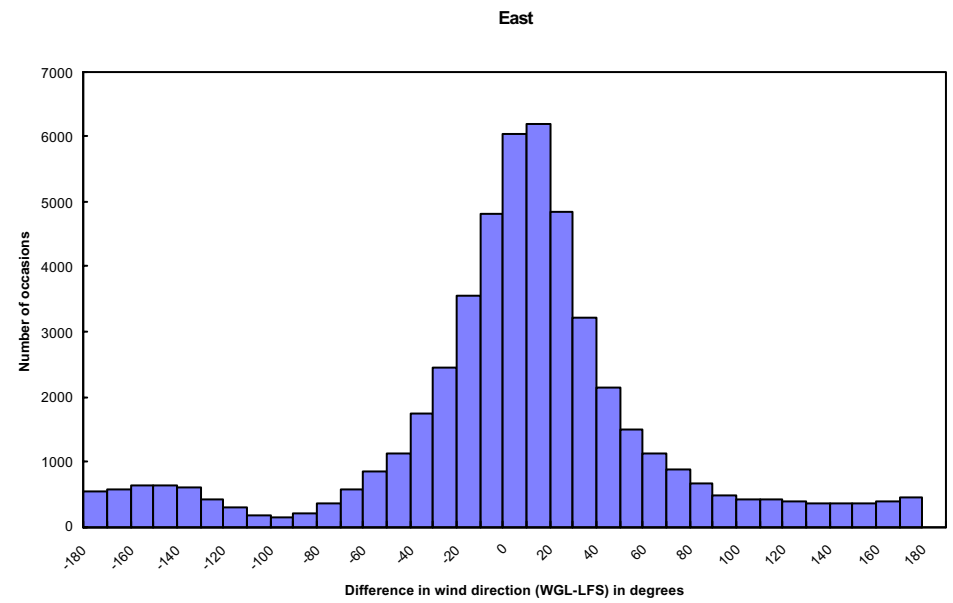
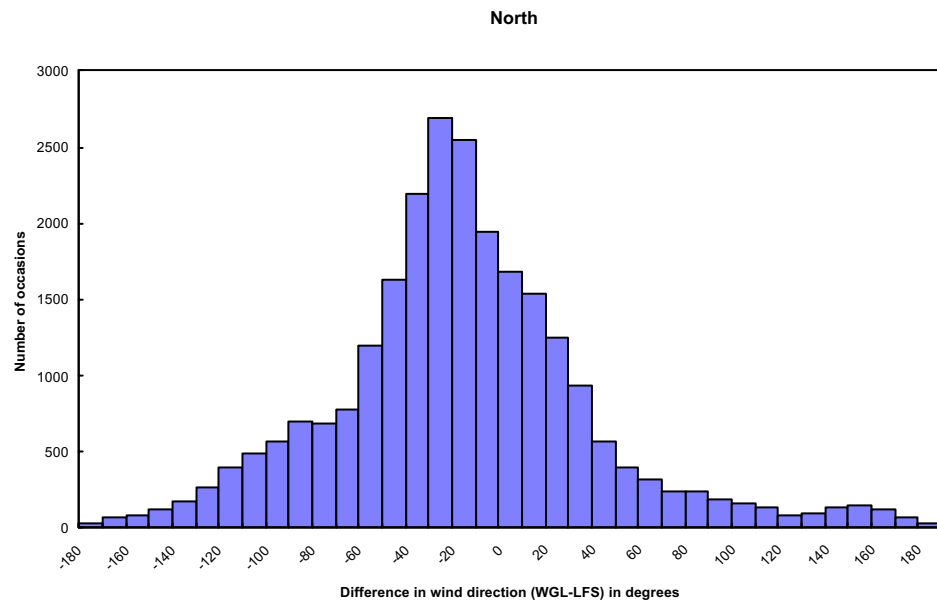

Fig. 13. Frequency distribution of the difference in hourly mean wind directions between Lau Fau Shan (LFS) and Waglan Island (WGL), grouped according to the wind direction at Waglan Island.

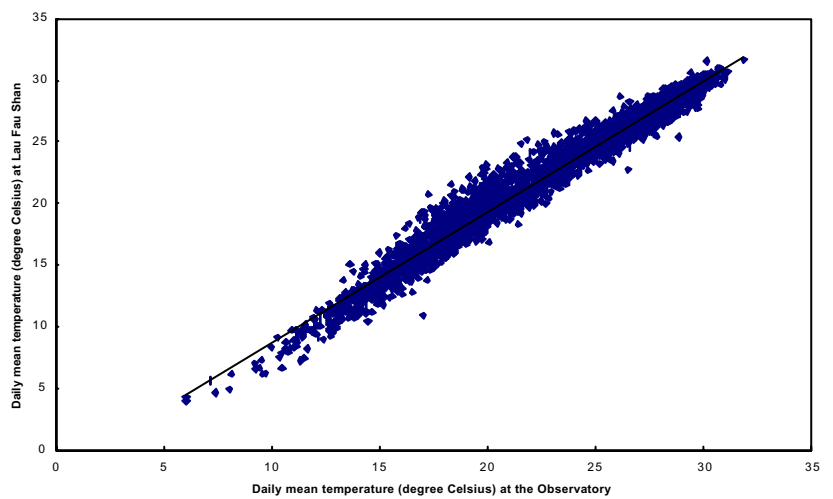
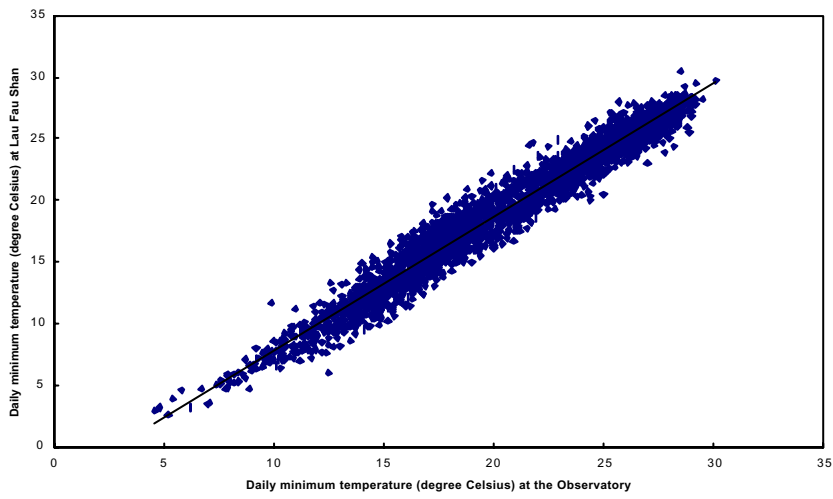
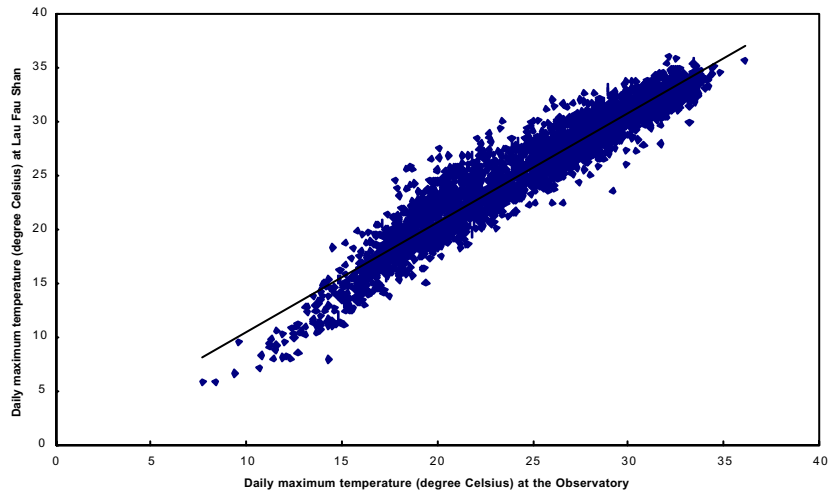

Fig. 14. Comparison of daily maximum, minimum and mean temperatures between Lau Fau Shan and the Observatory.

TABLE 1.

CLIMATOLOGICAL SUMMARY FOR LAU FAU SHAN, 1986-1997

Month	Air Temperature							Dew Point * °C	Relative Humidity * %	Mean Sea Level Pressure hPa	Prevailing Wind Direction degrees	Wind Speed m/s	Maximum Gust m/s
	24-hour	Mean Daily		Absolute Extremes									
	Mean °C	Maximum °C	Minimum °C	Maximum °C	Date	Minimum °C	Date						
January	15.2	18.9	12.2	26.7	07/01/89 08/01/89	3.2	18/01/93	10.6	76	1020.7	060	3.6	22.8
February	15.6	19.0	12.9	28.1	10/02/87	3.5	01/02/90	11.7	78	1019.0	070	3.7	18.1
March	18.6	22.3	16.0	31.6	15/03/88	3.2	01/03/86	14.8	80	1016.0	060	3.8	23.3
April	22.2	25.7	19.7	32.7	27/04/94	8.8	03/04/96	19.2	83	1013.1	070	3.6	29.2
May	25.6	29.0	23.1	34.5	24/05/91 25/05/91	17.9	05/05/90	22.4	83	1009.2	130	3.7	32.0
June	27.7	30.7	25.3	34.9	04/06/91	19.9	08/06/87	24.2	82	1006.4	130	3.9	39.9
July	28.2	31.5	25.6	36.0	12/07/89	20.5	10/07/92	24.9	82	1006.0	130	3.8	40.6
August	28.0	31.3	25.6	35.8	27/08/90	22.2	18/08/96	24.7	82	1006.1	130	3.5	32.2
September	27.1	30.4	24.5	35.1	01/09/90	17.5	21/09/97	23.2	79	1009.6	070	3.3	41.4
October	24.4	28.2	21.5	33.7	1987/12/10	13.4	31/10/88	18.7	72	1015.1	060	3.6	21.9
November	20.6	24.4	17.6	31.8	02/11/87	5.4	30/11/87	14.8	71	1018.6	060	3.5	25.9
December	16.9	20.7	13.8	28.3	01/12/94	2.6	29/12/91	11.8	73	1021.2	060	3.3	17.6
Year	22.5	26.0	19.8	36.0	12/07/89	2.6	29/12/91	18.4	78	1013.4	070	3.6	41.4

* Jan 1986 - May 1995

TABLE 1. (cont'd)

Month	Rainfall			Number of Days with Rainfall					Number of Hours with Rainfall			
	Total mm	Maximum Daily mm	Maximum Hourly mm	>=0.5 mm	>=10.0 mm	>=25.0 mm	>=50.0 mm	>=100.0 mm	>=0.5 mm	>=10.0 mm	>=25.0 mm	>=50.0 mm
January	18.2	36.0	9.0	4.42	0.42	0.08	-	-	18.00	-	-	-
February	43.5	36.5	11.5	8.08	1.58	0.25	-	-	30.33	0.25	-	-
March	53.6	84.5	37.0	8.50	1.33	0.50	0.25	-	28.50	1.00	0.25	-
April	120.9	92.5	46.5	8.67	3.25	1.25	0.50	-	36.50	2.75	0.33	-
May	194.9	199.5	37.0	11.83	4.42	2.17	0.58	0.25	47.92	5.25	1.25	-
June	248.9	184.0	70.5	14.67	5.25	2.33	1.00	0.33	69.58	4.50	0.75	0.25
July	328.8	332.0	55.0	15.75	7.33	3.25	1.50	0.50	79.67	7.42	1.25	0.17
August	235.4	125.0	32.5	13.33	6.75	2.67	0.67	0.17	67.17	5.08	0.67	-
September	138.5	103.0	30.0	10.08	4.00	1.83	0.58	0.08	43.42	2.83	0.42	-
October	58.7	48.5	27.5	4.08	0.75	0.42	-	-	15.50	0.50	0.17	-
November	55.9	209.5	56.5	4.17	0.83	0.42	0.25	0.08	19.75	0.67	0.25	0.17
December	32.1	107.5	21.0	4.17	0.58	0.17	0.17	0.08	22.08	0.33	-	-
Year	1529.4	332.0	70.5	107.75	36.49	15.34	5.50	1.49	478.42	30.58	5.34	0.59

TABLE 1. (cont'd)

Month	Number of Days with Maximum Temperature					Number of Days with Minimum Temperature				
	>=30°C	>=33°C	>=34°C	>=35°C	>=36°C	<=12°C	<=10°C	<=5°C	<=4°C	<=3°C
January	-	-	-	-	-	13.92	8.08	0.58	0.25	-
February	-	-	-	-	-	11.58	6.08	0.42	0.25	-
March	0.33	-	-	-	-	5.42	2.42	0.17	0.08	-
April	4.58	-	-	-	-	0.50	0.25	-	-	-
May	10.83	1.58	0.33	-	-	-	-	-	-	-
June	18.42	4.00	0.92	-	-	-	-	-	-	-
July	25.08	6.83	2.33	0.42	0.08	-	-	-	-	-
August	22.67	5.58	1.42	0.33	-	-	-	-	-	-
September	18.42	2.42	0.50	0.08	-	-	-	-	-	-
October	5.92	0.08	-	-	-	-	-	-	-	-
November	0.50	-	-	-	-	1.58	0.50	-	-	-
December	-	-	-	-	-	9.25	3.75	0.25	0.17	0.17
Year	106.75	20.49	5.50	0.83	0.08	42.25	21.08	1.42	0.75	0.17

Table 2.

PERCENTAGE FREQUENCY OF OCCURRENCE OF HOURLY WIND DIRECTION
AND SPEED WITHIN SPECIFIED RANGES AT LAU FAU SHAN, 1986-1997

Month	Wind speed (m/s)	Wind direction (degree)											
		30	60	90	120	150	180	210	240	270	300	330	360
January	0.1 - 3.2	6.49	11.29	8.81	4.12	1.32	0.28	0.66	2.04	1.60	2.07	2.42	3.53
	3.3 - 8.2	9.96	15.49	5.65	2.31	0.41	0.07	0.54	4.50	1.31	2.44	2.37	7.47
	8.3 - 14.2	0.25	0.18	0.20	0.02	0.01	0.00	0.00	0.03	0.05	0.23	0.17	0.31
	> 14.2	0.00	0.00	0.00	0.00	0.00	0.00	0.00	0.00	0.00	0.01	0.00	0.00
February	0.1 - 3.2	6.49	9.47	7.88	4.09	1.41	0.43	0.76	1.90	1.58	1.45	2.28	3.33
	3.3 - 8.2	11.01	15.94	8.11	3.90	1.80	0.24	0.39	3.75	1.10	2.03	2.31	5.89
	8.3 - 14.2	0.21	0.31	0.44	0.08	0.08	0.00	0.00	0.01	0.00	0.09	0.01	0.08
	> 14.2	0.00	0.00	0.00	0.00	0.00	0.00	0.00	0.00	0.00	0.00	0.00	0.00
March	0.1 - 3.2	5.71	10.11	7.89	4.65	2.48	0.49	0.69	1.83	1.47	1.16	1.49	2.91
	3.3 - 8.2	6.89	14.04	7.37	8.45	7.79	1.50	0.90	3.22	0.98	0.85	1.36	3.53
	8.3 - 14.2	0.00	0.07	0.13	0.36	0.33	0.07	0.00	0.05	0.00	0.20	0.15	0.34
	> 14.2	0.00	0.00	0.00	0.00	0.00	0.00	0.00	0.00	0.00	0.01	0.00	0.00
April	0.1 - 3.2	4.30	9.69	8.05	7.13	3.96	1.16	0.94	1.91	1.94	1.44	1.46	2.30
	3.3 - 8.2	4.16	11.92	7.69	9.64	8.15	2.09	2.00	3.79	1.61	0.58	0.50	1.68
	8.3 - 14.2	0.00	0.10	0.19	0.16	0.22	0.10	0.35	0.10	0.01	0.04	0.02	0.01
	> 14.2	0.00	0.00	0.00	0.00	0.00	0.00	0.01	0.00	0.00	0.00	0.00	0.00
May	0.1 - 3.2	2.80	7.56	9.24	9.59	5.48	1.48	0.91	1.08	1.52	1.59	1.56	1.82
	3.3 - 8.2	2.55	7.37	7.35	11.29	9.03	3.89	2.21	4.33	1.82	0.93	0.76	0.93
	8.3 - 14.2	0.06	0.24	0.15	0.17	0.09	0.23	0.68	0.13	0.03	0.07	0.05	0.01
	> 14.2	0.00	0.00	0.00	0.00	0.00	0.00	0.00	0.00	0.01	0.01	0.00	0.00
June	0.1 - 3.2	1.71	4.74	6.73	10.22	8.01	3.18	1.19	0.89	0.97	1.02	0.95	1.35
	3.3 - 8.2	0.59	4.68	5.40	10.92	11.34	8.62	5.01	4.63	1.65	0.74	0.48	0.57
	8.3 - 14.2	0.00	0.10	0.24	0.19	0.29	0.65	1.07	0.24	0.08	0.02	0.01	0.01
	> 14.2	0.00	0.02	0.02	0.05	0.00	0.00	0.01	0.01	0.01	0.00	0.00	0.00
July	0.1 - 3.2	1.51	4.47	6.64	10.74	8.92	4.15	1.74	1.06	1.41	1.06	0.85	1.14
	3.3 - 8.2	0.57	3.27	5.19	9.90	9.29	5.27	4.48	8.60	2.86	0.88	0.37	0.42
	8.3 - 14.2	0.09	0.26	0.41	0.36	0.34	0.48	0.48	0.27	0.19	0.38	0.09	0.07
	> 14.2	0.00	0.00	0.01	0.00	0.02	0.06	0.02	0.00	0.02	0.14	0.03	0.01
August	0.1 - 3.2	2.00	6.51	8.49	11.43	7.00	3.67	2.28	1.84	2.01	1.62	1.74	1.46
	3.3 - 8.2	1.00	6.34	5.23	6.07	4.08	3.60	5.04	8.26	3.15	1.57	0.64	0.53
	8.3 - 14.2	0.12	0.53	0.47	0.32	0.06	0.34	0.29	0.12	0.15	0.23	0.09	0.12
	> 14.2	0.00	0.00	0.00	0.01	0.00	0.04	0.01	0.04	0.04	0.06	0.02	0.00

Table 2 (cont'd)

Month	Wind speed (m/s)	Wind direction (degree)											
		30	60	90	120	150	180	210	240	270	300	330	360
September	0.1 - 3.2	4.64	10.06	10.05	10.55	3.78	0.93	1.53	1.55	1.74	2.05	2.39	2.71
	3.3 - 8.2	5.95	8.80	5.39	3.76	2.03	0.87	1.63	3.99	2.04	2.32	2.91	4.43
	8.3 - 14.2	0.12	0.22	0.32	0.05	0.00	0.00	0.12	0.14	0.21	0.37	0.25	0.26
	> 14.2	0.00	0.00	0.04	0.04	0.00	0.00	0.00	0.00	0.00	0.09	0.01	0.00
October	0.1 - 3.2	4.48	10.39	11.50	8.91	2.11	0.42	0.47	0.69	1.05	1.52	1.55	2.39
	3.3 - 8.2	10.26	14.06	8.50	3.35	0.76	0.12	0.53	2.87	1.07	0.84	1.69	7.28
	8.3 - 14.2	0.16	0.22	0.41	0.02	0.00	0.00	0.00	0.00	0.01	0.04	0.16	1.01
	> 14.2	0.00	0.00	0.00	0.00	0.00	0.00	0.00	0.00	0.00	0.00	0.00	0.00
November	0.1 - 3.2	6.34	11.74	11.09	5.77	1.49	0.27	0.74	1.38	1.43	1.48	2.28	3.21
	3.3 - 8.2	11.60	15.17	6.84	1.75	0.44	0.24	0.51	2.47	0.93	1.18	1.61	7.13
	8.3 - 14.2	0.19	0.09	0.31	0.01	0.00	0.01	0.00	0.00	0.00	0.13	0.15	1.00
	> 14.2	0.00	0.00	0.00	0.00	0.00	0.00	0.00	0.00	0.00	0.00	0.00	0.00
December	0.1 - 3.2	6.43	13.27	10.93	5.53	1.44	0.39	0.85	2.18	1.93	2.21	2.26	3.81
	3.3 - 8.2	11.75	13.69	4.74	1.90	0.45	0.07	0.68	3.57	0.79	1.16	1.60	6.75
	8.3 - 14.2	0.07	0.07	0.05	0.00	0.00	0.00	0.00	0.00	0.01	0.08	0.09	0.37
	> 14.2	0.00	0.00	0.00	0.00	0.00	0.00	0.00	0.00	0.00	0.00	0.00	0.00
Overall	0.1 - 3.2	4.42	9.12	8.94	7.69	3.94	1.40	1.06	1.53	1.55	1.55	1.76	2.50
	3.3 - 8.2	6.38	10.93	6.46	6.12	4.65	2.21	1.98	4.50	1.60	1.28	1.37	3.89
	8.3 - 14.2	0.11	0.20	0.27	0.15	0.12	0.16	0.25	0.09	0.06	0.16	0.10	0.30
	> 14.2	0.00	0.00	0.01	0.01	0.00	0.01	0.00	0.00	0.01	0.03	0.01	0.00

STATISTICS OF THE OBSERVATIONS OF CALM AND VARIABLE WINDS AT LAU FAU SHAN, 1986-1997

Month	Jan	Feb	Mar	Apr	May	Jun	Jul	Aug	Sep	Oct	Nov	Dec	Overall
Number of observations	8691	7992	8792	8260	8638	8248	8612	8170	7602	8498	8469	8631	100603
Number of variable winds	60	73	46	49	57	51	70	64	50	72	45	54	691
Percentage of variable winds (%)	0.69	0.91	0.52	0.59	0.66	0.62	0.81	0.78	0.66	0.85	0.53	0.63	0.69
Number of calm winds	60	18	0	0	28	62	58	51	76	24	42	22	441
Percentage of calm winds (%)	0.69	0.23	0.00	0.00	0.32	0.75	0.67	0.62	1.00	0.28	0.50	0.25	0.44

TABLE 3.

HOURLY VECTOR MEAN WIND AT LAU FAU SHAN, 1986-1997

HOUR	JAN		FEB		MAR		APR		MAY		JUN		JUL		AUG		SEP		OCT		NOV		DEC	
	dir	spd	dir	spd	dir	spd	dir	spd	dir	spd	dir	spd	dir	spd	dir	spd	dir	spd	dir	spd	dir	spd	dir	spd
0100	55	2.6	57	2.6	79	2.5	92	2.3	106	2.3	126	2.2	130	1.7	117	1.4	70	1.6	64	2.6	58	2.6	57	2.6
0200	51	2.7	55	2.7	75	2.5	87	2.3	105	2.1	130	2.1	131	1.6	119	1.3	64	1.7	61	2.6	57	2.7	55	2.7
0300	48	2.8	54	2.8	72	2.5	84	2.2	101	1.9	128	1.9	130	1.6	115	1.2	58	1.7	57	2.6	54	2.8	53	2.7
0400	50	2.9	54	2.8	72	2.5	84	2.2	102	1.9	128	1.9	134	1.5	116	1.1	53	1.7	55	2.7	54	2.8	52	2.8
0500	50	3.0	57	2.8	75	2.5	82	2.2	98	1.8	126	1.7	136	1.5	111	1.1	50	1.8	53	2.7	53	2.8	53	2.8
0600	51	2.9	57	2.9	73	2.3	82	2.3	95	1.8	123	1.7	132	1.4	110	1.2	48	1.7	53	2.8	53	2.9	51	2.8
0700	51	2.9	56	2.9	73	2.3	84	2.2	95	1.8	122	1.8	132	1.3	104	1.0	50	1.7	53	2.9	53	3.0	50	2.8
0800	51	2.8	56	2.9	75	2.3	86	2.1	96	1.8	130	1.6	144	1.2	108	0.8	46	1.7	51	2.8	49	2.9	51	2.8
0900	49	2.7	53	2.8	75	2.3	85	1.9	101	1.5	142	1.6	155	1.3	113	0.4	39	1.9	46	3.2	45	3.0	50	2.7
1000	42	2.8	52	2.9	73	2.1	78	1.7	100	1.2	164	1.6	170	1.2	116	0.2	36	1.9	40	3.3	38	3.2	41	2.8
1100	33	2.9	44	2.7	70	1.9	89	1.4	123	0.9	177	1.9	188	1.6	229	0.3	26	1.7	32	3.2	30	3.2	30	2.9
1200	21	2.5	33	2.3	73	1.6	90	1.0	159	0.8	189	2.1	199	2.0	219	0.9	10	1.2	26	2.6	21	2.8	16	2.6
1300	4	1.9	27	1.7	81	0.9	143	0.7	176	1.2	188	2.6	198	2.2	220	1.3	339	0.7	20	1.9	14	2.2	2	1.9
1400	336	1.5	19	1.1	112	0.5	168	1.0	186	1.5	188	2.7	197	2.4	219	1.7	293	0.7	7	1.2	359	1.6	335	1.3
1500	309	1.4	1	0.8	128	0.6	173	1.3	173	1.8	180	2.8	188	2.5	210	1.8	275	0.6	359	0.8	351	1.2	311	1.1
1600	300	1.4	348	0.6	127	0.8	162	1.2	163	1.9	167	2.9	188	2.6	201	1.8	272	0.4	10	0.7	342	0.9	305	1.0
1700	316	1.1	25	0.6	123	1.1	145	1.6	152	2.1	163	3.1	174	2.5	181	1.8	230	0.2	42	1.0	357	0.9	322	0.9
1800	355	0.9	47	1.0	107	1.4	131	2.0	139	2.4	154	3.1	159	2.6	159	1.9	120	0.5	62	1.5	35	1.2	14	1.0
1900	38	1.4	68	1.6	97	2.0	120	2.2	127	2.6	145	3.1	147	2.6	140	2.0	96	1.2	73	2.0	56	1.8	48	1.5
2000	58	1.9	70	1.9	94	2.3	112	2.4	119	2.8	138	2.9	137	2.4	128	2.2	86	1.4	81	2.3	70	2.2	68	1.9
2100	64	2.0	71	2.2	93	2.4	108	2.5	116	2.8	135	2.8	130	2.2	122	2.0	83	1.6	81	2.5	71	2.3	71	2.2
2200	64	2.2	68	2.4	92	2.5	104	2.5	114	2.7	131	2.7	128	2.1	117	1.9	80	1.7	79	2.6	66	2.4	66	2.3
2300	60	2.3	64	2.5	87	2.5	101	2.6	111	2.6	128	2.7	127	2.0	118	1.9	77	1.7	73	2.6	65	2.5	63	2.4
2400	55	2.5	63	2.6	82	2.5	100	2.4	109	2.5	126	2.5	129	1.7	113	1.6	73	1.7	70	2.7	59	2.5	60	2.6

dir : wind direction (degree)
spd : wind speed (m/s)

TABLE 4.

HOURLY MEAN OF MEAN SEA-LEVEL PRESSURE (hPa) AT LAU FAU SHAN, 1986-1997

HOUR	JAN	FEB	MAR	APR	MAY	JUN	JUL	AUG	SEP	OCT	NOV	DEC
0100	1021.1	1019.4	1016.4	1013.4	1009.4	1006.7	1006.4	1006.4	1009.8	1015.2	1018.9	1021.5
0200	1020.8	1019.1	1016.0	1012.9	1009.0	1006.3	1006.0	1006.0	1009.4	1014.9	1018.6	1021.3
0300	1020.5	1018.7	1015.7	1012.4	1008.7	1006.1	1005.8	1005.7	1009.1	1014.7	1018.4	1021.0
0400	1020.3	1018.5	1015.3	1012.3	1008.6	1006.0	1005.7	1005.6	1009.0	1014.6	1018.3	1020.9
0500	1020.4	1018.5	1015.5	1012.5	1008.8	1006.1	1005.7	1005.7	1009.2	1014.7	1018.4	1021.0
0600	1020.8	1019.0	1015.9	1012.9	1009.2	1006.4	1006.0	1005.9	1009.5	1015.2	1018.8	1021.3
0700	1021.3	1019.6	1016.6	1013.5	1009.7	1006.8	1006.4	1006.4	1010.0	1015.8	1019.5	1021.9
0800	1021.9	1020.1	1017.2	1014.2	1010.2	1007.2	1006.7	1006.8	1010.5	1016.4	1020.1	1022.5
0900	1022.5	1020.6	1017.7	1014.7	1010.5	1007.4	1006.9	1007.1	1010.9	1016.8	1020.5	1023.1
1000	1022.8	1020.9	1017.8	1014.8	1010.6	1007.5	1007.0	1007.2	1011.1	1016.8	1020.6	1023.3
1100	1022.4	1020.7	1017.6	1014.6	1010.4	1007.3	1006.9	1007.1	1010.8	1016.4	1020.0	1022.8
1200	1021.5	1019.9	1016.9	1014.1	1009.9	1007.0	1006.6	1006.7	1010.2	1015.5	1019.1	1021.9
1300	1020.3	1018.9	1016.0	1013.3	1009.4	1006.6	1006.2	1006.1	1009.5	1014.6	1018.1	1020.7
1400	1019.4	1018.0	1015.1	1012.4	1008.7	1006.1	1005.6	1005.6	1008.8	1013.8	1017.2	1019.8
1500	1018.9	1017.3	1014.4	1011.8	1008.1	1005.6	1005.1	1005.0	1008.2	1013.3	1016.7	1019.3
1600	1018.7	1017.1	1014.1	1011.4	1007.7	1005.1	1004.8	1004.7	1008.0	1013.2	1016.7	1019.3
1700	1019.0	1017.3	1014.2	1011.3	1007.6	1005.0	1004.6	1004.6	1008.1	1013.4	1017.0	1019.6
1800	1019.4	1017.6	1014.4	1011.6	1007.8	1005.2	1004.7	1004.8	1008.3	1013.8	1017.4	1020.1
1900	1019.9	1017.9	1014.9	1012.1	1008.3	1005.6	1005.2	1005.3	1008.8	1014.3	1018.0	1020.6
2000	1020.5	1018.6	1015.4	1012.7	1008.8	1006.2	1005.7	1005.9	1009.4	1015.1	1018.6	1021.1
2100	1020.9	1019.1	1016.1	1013.2	1009.3	1006.6	1006.3	1006.5	1010.1	1015.6	1019.0	1021.5
2200	1021.1	1019.4	1016.5	1013.8	1009.8	1007.1	1006.8	1007.0	1010.5	1015.8	1019.3	1021.8
2300	1021.2	1019.5	1016.6	1013.9	1010.0	1007.3	1007.0	1007.1	1010.5	1015.8	1019.4	1021.8
2400	1021.2	1019.5	1016.6	1013.6	1009.8	1007.0	1006.7	1006.9	1010.3	1015.6	1019.2	1021.6
MEAN	1020.7	1019.0	1016.0	1013.1	1009.2	1006.4	1006.0	1006.1	1009.6	1015.1	1018.6	1021.2

TABLE 5.

HOURLY MEAN OF AIR TEMPERATURE (°C) AT LAU FAU SHAN, 1986-1997

HOUR	JAN	FEB	MAR	APR	MAY	JUN	JUL	AUG	SEP	OCT	NOV	DEC
0100	14.1	14.6	17.6	20.9	24.3	26.5	27.0	26.9	25.9	23.0	19.3	15.7
0200	13.8	14.4	17.4	20.8	24.1	26.4	26.9	26.8	25.8	22.8	19.0	15.3
0300	13.6	14.2	17.2	20.6	24.0	26.3	26.8	26.7	25.6	22.5	18.8	15.1
0400	13.4	14.0	17.0	20.5	23.9	26.2	26.7	26.5	25.4	22.3	18.6	14.9
0500	13.2	13.8	16.9	20.4	23.8	26.1	26.5	26.4	25.2	22.1	18.4	14.7
0600	13.0	13.7	16.8	20.4	23.7	26.0	26.4	26.3	25.1	21.9	18.2	14.5
0700	12.9	13.6	16.8	20.6	24.2	26.6	27.0	26.7	25.3	22.0	18.1	14.4
0800	13.3	14.0	17.5	21.5	25.2	27.4	27.9	27.6	26.3	23.3	19.2	15.0
0900	14.5	15.0	18.4	22.3	25.9	28.0	28.5	28.2	27.2	24.4	20.3	16.3
1000	15.4	15.9	19.3	23.0	26.4	28.5	28.9	28.6	27.8	25.3	21.2	17.4
1100	16.3	16.6	20.0	23.7	26.9	28.8	29.3	29.2	28.5	26.0	22.0	18.2
1200	17.0	17.1	20.4	24.0	27.4	29.2	29.6	29.6	28.9	26.6	22.6	18.8
1300	17.5	17.5	20.6	24.2	27.6	29.4	29.9	30.0	29.2	27.0	23.2	19.4
1400	17.7	17.7	20.7	24.3	27.6	29.6	30.2	30.2	29.2	27.3	23.4	19.7
1500	17.7	17.8	20.7	24.3	27.7	29.5	30.2	30.2	29.2	27.2	23.5	19.8
1600	17.5	17.6	20.5	24.0	27.4	29.4	30.0	29.9	29.0	26.9	23.2	19.6
1700	17.1	17.3	20.1	23.6	27.0	29.1	29.8	29.5	28.6	26.3	22.6	19.0
1800	16.4	16.7	19.5	23.0	26.4	28.5	29.2	28.9	28.0	25.4	21.8	18.2
1900	15.9	16.1	18.9	22.4	25.7	27.8	28.4	28.1	27.3	24.7	21.2	17.7
2000	15.4	15.7	18.6	22.1	25.2	27.3	27.9	27.7	26.9	24.3	20.6	17.2
2100	15.1	15.5	18.3	21.8	25.0	27.1	27.6	27.5	26.7	23.9	20.3	16.7
2200	14.8	15.2	18.2	21.6	24.8	27.0	27.4	27.3	26.5	23.6	19.9	16.4
2300	14.5	15.0	18.0	21.5	24.6	26.8	27.3	27.2	26.3	23.4	19.6	16.1
2400	14.3	14.8	17.8	21.3	24.5	26.7	27.2	27.0	26.1	23.1	19.4	15.9
MEAN	15.2	15.6	18.6	22.2	25.6	27.7	28.2	28.0	27.1	24.4	20.6	16.9

TABLE 6.

HOURLY MEAN OF DEW POINT (°C) AT LAU FAU SHAN, 1986 -1997

HOUR	JAN	FEB	MAR	APR	MAY	JUN	JUL	AUG	SEP	OCT	NOV	DEC
0100	10.6	11.8	14.7	18.9	22.1	24.0	24.7	24.5	23.2	18.9	14.9	11.8
0200	10.5	11.7	14.6	18.9	22.1	24.0	24.7	24.6	23.1	18.8	14.8	11.6
0300	10.3	11.5	14.5	18.8	22.1	24.0	24.8	24.6	23.1	18.8	14.7	11.5
0400	10.2	11.3	14.4	18.8	22.1	24.0	24.7	24.5	23.0	18.6	14.6	11.3
0500	10.0	11.2	14.3	18.7	22.1	24.0	24.7	24.5	22.9	18.3	14.3	11.1
0600	9.8	11.0	14.2	18.6	22.0	24.0	24.6	24.5	22.8	18.1	14.1	10.9
0700	9.7	11.0	14.1	18.8	22.2	24.3	25.0	24.7	22.9	18.0	13.9	10.7
0800	9.7	11.1	14.3	18.9	22.4	24.4	25.1	24.9	23.1	18.2	14.1	10.7
0900	9.9	11.2	14.4	19.1	22.4	24.4	25.1	24.9	23.2	18.1	14.1	10.9
1000	10.1	11.4	14.6	19.2	22.5	24.4	25.1	24.9	23.2	18.2	14.2	11.0
1100	10.4	11.6	14.8	19.3	22.7	24.5	25.1	24.9	23.2	18.2	14.4	11.4
1200	10.6	11.8	14.9	19.5	22.8	24.5	25.1	24.9	23.2	18.4	14.7	11.5
1300	10.9	12.0	15.1	19.5	22.9	24.5	25.1	25.0	23.3	18.7	14.9	12.0
1400	11.3	12.2	15.2	19.6	22.9	24.5	25.1	25.0	23.4	18.9	15.2	12.5
1500	11.4	12.4	15.4	19.7	23.0	24.5	25.2	25.1	23.5	19.1	15.5	12.7
1600	11.5	12.4	15.4	19.7	22.8	24.5	25.1	25.0	23.4	19.3	15.5	12.7
1700	11.5	12.3	15.3	19.6	22.7	24.4	25.1	24.9	23.4	19.3	15.6	12.8
1800	11.3	12.2	15.1	19.5	22.5	24.2	25.0	24.7	23.3	19.2	15.4	12.4
1900	11.0	12.0	15.0	19.3	22.3	24.0	24.8	24.4	23.2	19.2	15.3	12.3
2000	10.9	11.9	15.0	19.3	22.3	24.0	24.7	24.4	23.2	19.3	15.2	12.1
2100	10.8	11.9	14.9	19.3	22.2	24.0	24.7	24.4	23.2	19.2	15.1	12.1
2200	10.8	11.9	14.9	19.3	22.2	24.0	24.7	24.4	23.2	19.0	15.1	12.0
2300	10.7	11.8	14.9	19.3	22.3	24.0	24.7	24.5	23.1	19.0	15.0	12.0
2400	10.7	11.8	14.9	19.2	22.3	24.0	24.8	24.5	23.1	18.9	14.9	11.9
MEAN	10.6	11.7	14.8	19.2	22.4	24.2	24.9	24.7	23.2	18.7	14.8	11.8

TABLE 7.

HOURLY MEAN OF RELATIVE HUMIDITY (%) AT TA KWU LING, 1989-1997

HOUR	JAN	FEB	MAR	APR	MAY	JUN	JUL	AUG	SEP	OCT	NOV	DEC
0100	81	83	84	88	87	86	87	86	84	79	77	78
0200	81	83	85	88	88	87	87	87	84	79	77	79
0300	82	83	85	89	89	87	88	88	85	80	78	79
0400	82	84	86	89	89	88	89	88	86	81	78	79
0500	82	84	86	89	90	88	89	89	86	81	78	79
0600	82	84	86	89	90	89	89	90	86	80	78	79
0700	82	84	85	88	88	87	87	89	86	79	78	79
0800	80	82	83	85	84	84	83	85	82	74	74	76
0900	76	78	79	81	81	82	81	82	78	69	69	71
1000	72	75	76	79	79	79	79	80	75	66	66	67
1100	70	73	74	76	78	78	77	77	73	63	64	65
1200	68	72	73	76	76	77	76	76	71	62	63	64
1300	68	71	73	75	76	75	75	75	70	62	62	63
1400	68	71	73	75	76	75	74	74	70	61	62	64
1500	69	71	74	76	76	75	74	74	71	62	63	65
1600	70	72	75	77	76	75	75	75	71	64	64	66
1700	71	73	76	78	77	76	75	76	73	66	66	69
1800	74	75	78	80	79	78	77	77	75	69	69	70
1900	75	77	80	82	81	80	81	80	77	72	71	72
2000	76	78	81	84	83	82	82	82	79	74	72	73
2100	77	79	82	85	84	83	84	83	81	76	73	75
2200	78	80	83	86	85	84	85	84	82	76	75	75
2300	79	81	83	86	86	85	85	84	82	77	75	77
2400	80	82	84	87	87	85	86	85	83	78	76	78
MEAN	76	78	80	83	83	82	82	82	79	72	71	73

TABLE 8.

EXTREME VALUES OF TEMPERATURE, RAINFALL AND GUST AT LAU FAU SHAN, 1986-1997

Rank	Daily Temperature				Maximum Rainfall						Maximum Gust	
	Maximum °C	Date °C	Minimum	Date	Hourly mm	Time	Daily mm	Date	Monthly mm	Month	Hourly m/s	Time
1	36.0	12/07/89	2.6	29/12/91	70.5	12 16/06/93	332.0	22/07/94	774.5	Jul-94	41.4	8 17/09/93
2	35.8	27/08/90	2.9	28/12/91	69.5	7 04/06/97	209.5	05/11/93	573.0	May-89	40.6	9 18/07/92
3	35.6	18/08/90	3.2	01/03/86	63.0	13 16/06/93	199.5	21/05/89	555.5	Jul-97	39.9	17 27/06/93
4	35.5	08/07/89	3.2	18/01/93	56.5	8 05/11/93	184.0	16/06/93	514.0	Aug-97	36.8	10 18/07/92
5	35.4	04/07/89	3.5	01/02/90	55.0	5 20/07/88	173.5	20/05/89	442.0	Aug-94	35.3	9 17/09/93
6	35.4	19/08/89	3.6	17/01/93	54.0	7 22/07/94	147.5	20/07/88	403.0	Jun-92	34.4	10 17/09/93
7	35.1	01/07/87	3.6	21/02/96	51.5	9 05/11/93	145.5	13/06/92	380.5	Sep-93	34.1	12 17/09/93
8	35.1	17/08/90	3.7	20/02/96	49.0	8 22/07/94	134.0	02/07/97	318.5	Aug-95	33.7	11 17/09/93
9	35.1	01/09/90	3.9	16/01/93	49.0	10 22/07/94	125.0	06/08/94	317.5	Sep-96	33.4	19 06/07/92
10	35.1	19/07/91	4.6	02/03/86	44.0	2 22/07/94	124.0	02/08/97	310.5	Jun-97	32.7	18 27/06/93
11	34.9	03/07/89	4.7	07/12/87	44.0	4 20/07/88	115.0	23/07/94	307.5	Jul-95	32.5	20 27/06/93
12	34.9	21/08/89	4.7	15/01/93	38.0	22 28/06/92	110.0	13/06/97	293.0	Nov-93	32.2	17 31/08/95
13	34.9	26/08/90	4.7	29/01/93	37.0	2 21/05/89	109.0	31/07/91	278.0	Jun-94	32.0	16 17/05/94
14	34.9	04/06/91	4.8	19/01/93	37.0	18 26/03/92	107.5	08/12/94	276.5	May-93	31.7	11 12/08/95
15	34.8	21/07/89	4.9	19/02/96	37.0	7 05/11/93	103.0	26/09/93	269.5	Jun-93	31.4	22 04/08/94
16	34.8	10/08/89	4.9	22/02/96	36.0	14 13/06/92	88.0	22/08/97	266.5	Jun-91	31.4	10 12/08/95
17	34.7	25/06/87	5.0	24/01/93	34.5	11 16/06/93	87.5	09/05/93	264.0	Jul-91	30.8	11 18/07/92
18	34.7	13/08/89	5.1	14/01/89	34.0	19 19/04/95	85.5	04/06/97	263.5	Apr-92	30.8	23 02/08/97
19	34.7	02/09/90	5.2	30/12/91	33.5	5 21/05/89	83.0	14/09/96	240.0	Jul-88	30.7	21 27/06/93
20	34.6	09/08/89	5.3	28/02/86	33.5	22 25/05/96	81.0	15/05/92	223.5	Aug-89	30.6	16 27/06/93
*	36.1	18/08/90	4.6	28/12/91	109.9	07 08/05/92	324.1	08/05/92	1147.2	Jul-94	37.5	16 27/06/93

* : extreme values recorded at the Hong Kong Observatory during 1986-1997